

Malcolm E

1/6

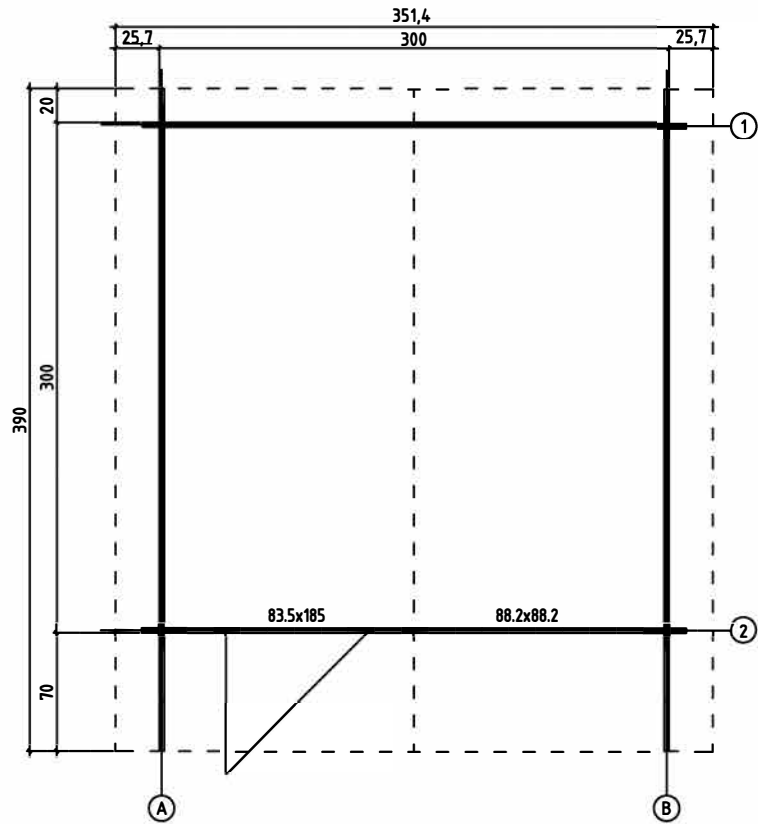

GROUNDPLAN - GRUNDPLAN - PLAN DE MASSE





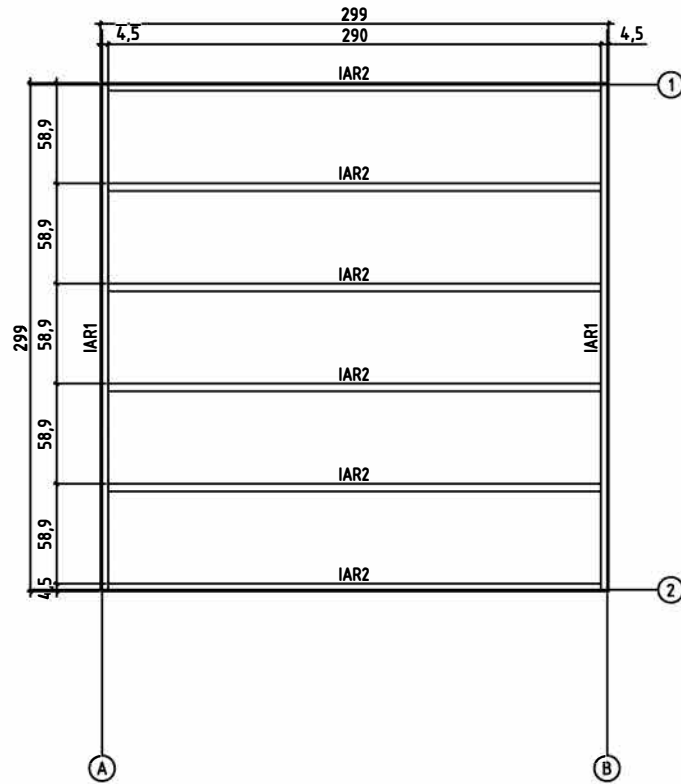



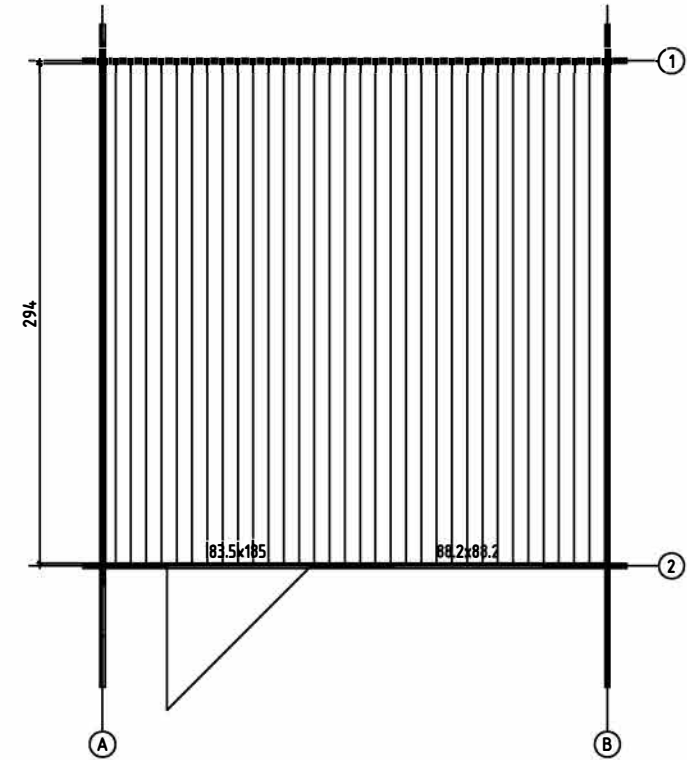

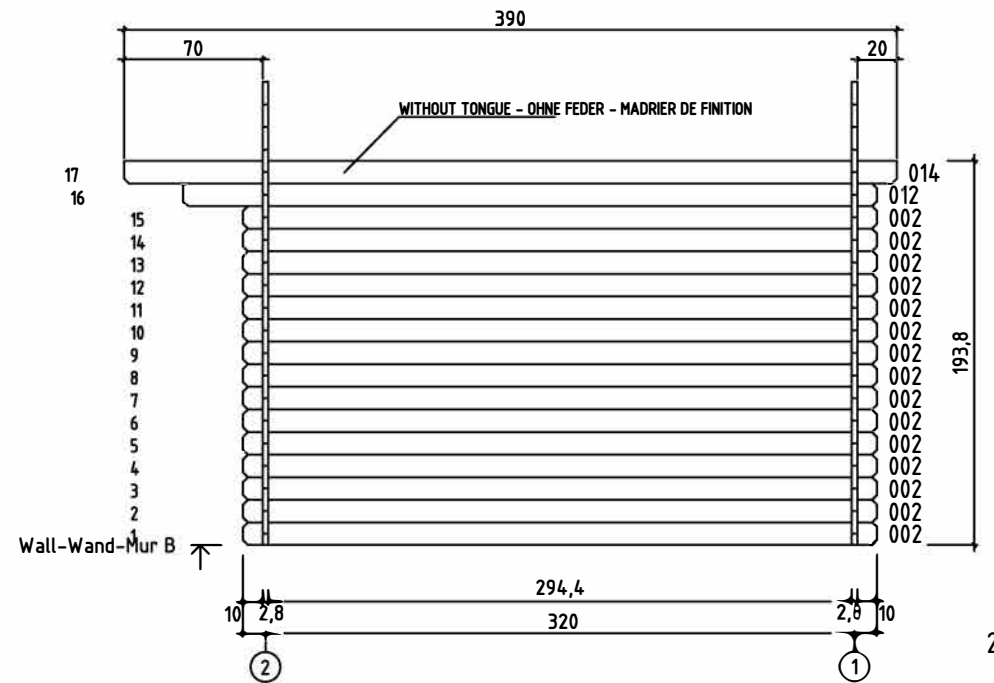
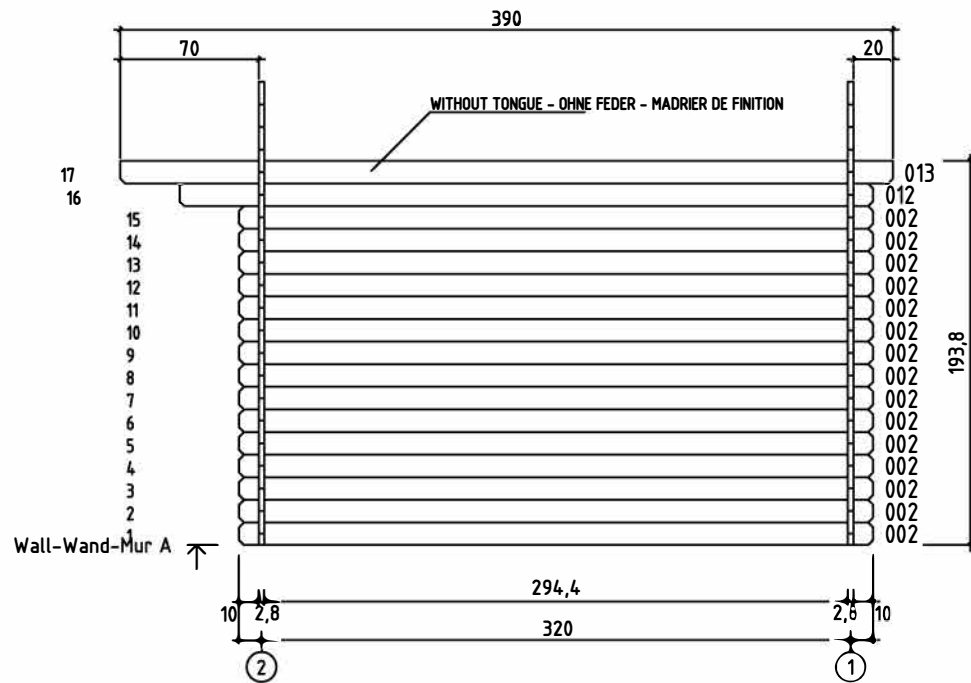
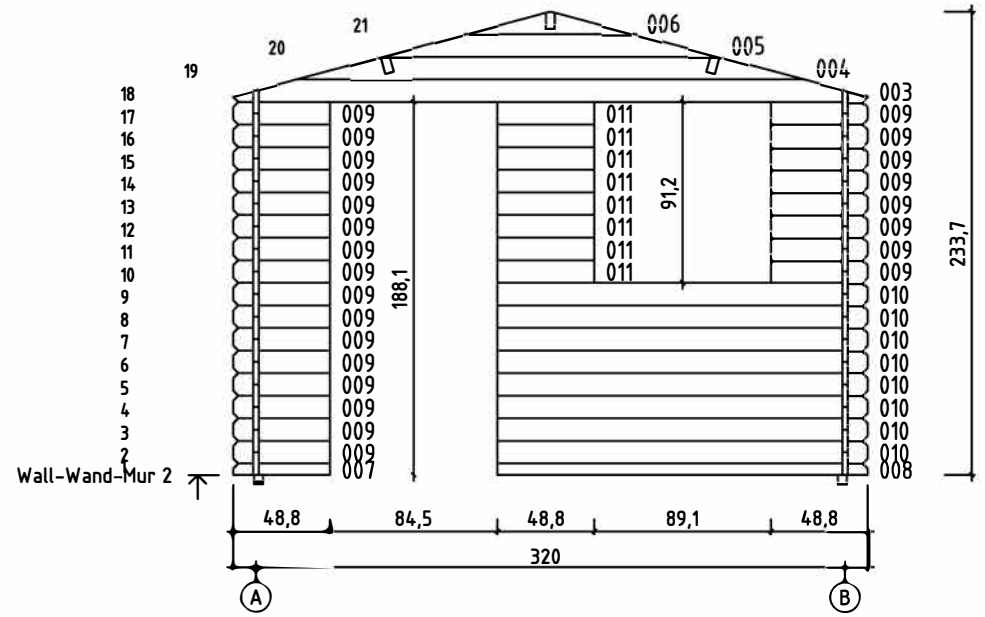
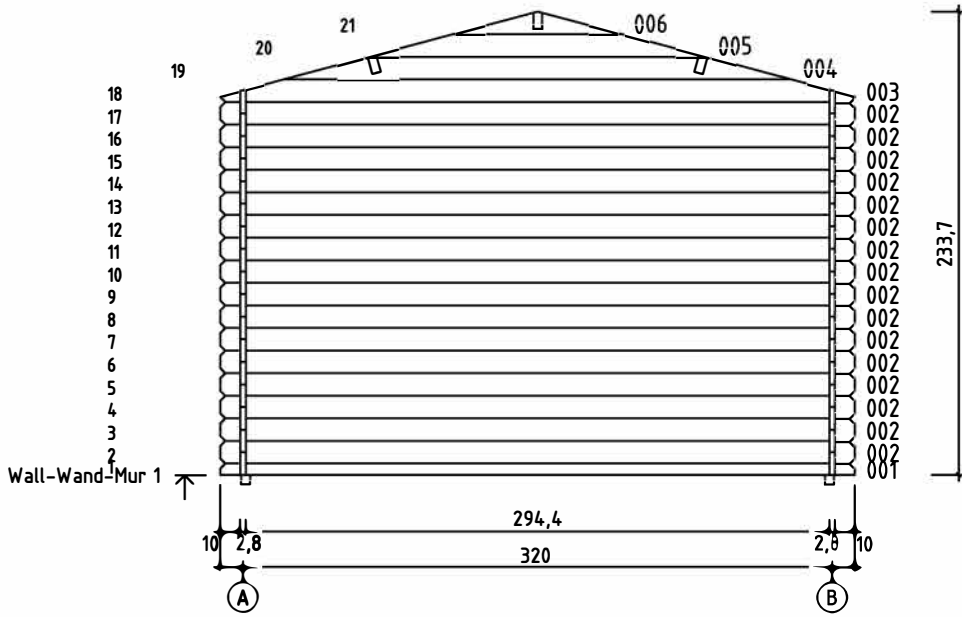

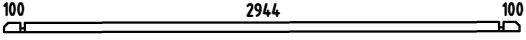
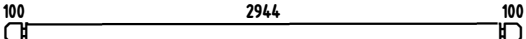

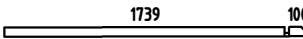

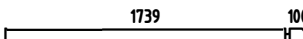
FOUNDATION - FUNDAMENT - FONDATION

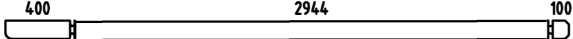
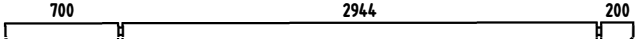
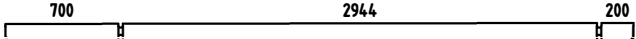
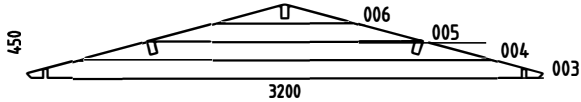
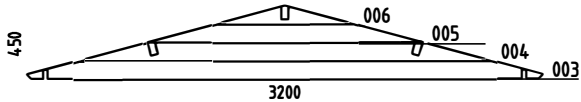
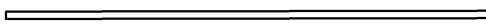

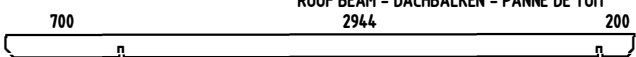
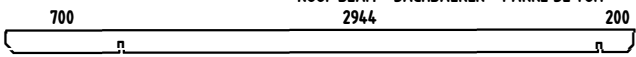

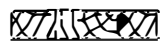

FLOOR BOARDS - FUSSBODENBRETTER - PLAN POSE PLANCHER

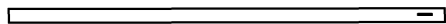

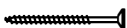

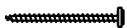
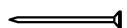
Pos	27.10.2010	4/6	Q.	P (mm)	L (mm)
001			1	28x57	3200
002			46	28x114	3200
007			1	28x57	488
008			1	28x57	1867
009			24	28x114	488
010			8	28x114	1867
011			8	28x114	488
012			2	28x114	3500
013			1	28x120	3900
014			1	28x120	3900
W1-1			1		
W2-1			1		
IAR1	FOUNDATION - FUNDAMENT - FONDATION 		2	45x45	2990
IAR2	FOUNDATION - FUNDAMENT - FONDATION 		6	45x45	2900
PR11	ROOF BEAM - DACHBALKEN - PANNE DE TOIT 		1	44x140	3900
PR21	ROOF BEAM - DACHBALKEN - PANNE DE TOIT 		2	44x140	3900
	FLOOR BOARDS - FUSSBODENBRETTER - LAME DE PLANCHER 		33	90x18	2940
	ROOF BOARDS - DACHBRETTER - VOLIGES 		88	90x18	1800
	FLOOR FILLET-FUSSBODENLEISTE - CORNIERE DE FINITION DU PLANCHER 			18x18	11.76
	ROOFING FELT FILLET - DACHPAPPENLEISTE - BAGUETTE DE FIXATION DU FEUTRE BITUMEUX 		4	18x58	1850
	EAVES BOARD - TRAUFBRETT - BANDEAU DE TOIT 		2	18x90	3900
	ROOF EDGE REINFORCEMENT - DACHRANDVERSTÄRKUNG - CORNIERE DE RENFORT DE BORD DE TOIT 		2	28x34	3900
	STORM PROTECTION - STURMLEISTE LATTE ANTI-TEMPETE 		4	22x45	1900

Pos	27.10.2010	5/6	Q.	P (mm)	L (mm)
	GABLE MOULDING - GIEBELLEISTE PLANCHE DE RIVE		4	18x120	1850
	WINDOW HANDLE FITTINGS-FENSTERGRIFF - POIGNÉE D'OUVERTURE DE FENETRE		1		
	SCREW FOR GABLE SEGMENT - SCHRAUBEN FÜR DECKBLATT - VIS POUR FIXATION LOSANGE DE FINITION		4	3.5x35	
	SCREW FOR GABLE MOULDING - SCHRAUBEN FÜR GIEBELLEISTE - VIS DE FIXATION POUR PLANCHE DE RIVE		24	3.5x50	
	SCREW FOR EAVES BOARDS - SCHRAUBEN FÜR TRAUFBRETT - VIS DE FIXATION POUR BANDEAU DE TOIT		18	4x40	
	SCREW FOR ROOF EDGE REINFORCEMENT - SCHRAUBEN FÜR DACHRANDVERSTÄRKUNG - VIS POUR RENFORT DE BORD DE TOIT		18	4x40	
	SCREW FOR ROOF BEAMS - SCHRAUBEN FÜR DACHBALKEN - VIS POUR PANNE DE TOIT		10	5x120	
	SCREW FOR 1. WALL BEAM - SCHRAUBE FÜR 1. BOHLENREIHE - VIS DE FIXATION DES FONDATIONS		6	5x90	
	SCREW FOR FUNDAMENT - SCHRAUBEN ZUR BEFESTIGUNG FUNDAMENT - VIS POUR FONDATION		12	5x90	
	ZN NAIL FOR FLOOR FILLET - ZN NÄGEL FÜR FUSSBODENLEISTE - POINTE POUR CORNIERE DE FINITION DU PLANCHER		24	1.4x40	
	HAMMER BLOCK - SCHLAGHOLZ - CALLE DE FRAPPE		1		
	SCREW FOR DOORSTEP - SCHRAUBEN FÜR TÜRSWELLE - VIS DE FIXATION DU SEUIL DE PORTE		2	4.5x65	
	ZN NAIL FOR ROOFING FELT FILLET - ZN NÄGEL FÜR DACHPAPPENLEISTE - POINTE POUR BAGUETTE FIXATION FEUTRE BITUMEUX		20	2x40	
	BOLT FOR WINDOW HANDLE FITTINGS - BOLZEN FÜR FENSTERGRIFF BESCHLAG - BOULON POUR POIGNÉE D'OUVERTURE DE FENETRE		2		
	GABLE SEGMENT-DECKBLATT - LOSANGE DE FINITION		2		
	NUT FOR STORM PROTECTION - SCHRAUBENMUTTER FÜR STURMLEISTE - ÉCROU POUR LAME ANTI-TEMPETE		8		
	BOLT FOR STORM PROTECTION - BOLZEN FÜR STURMLEISTE - VIS POUR LAME ANTI-TEMPETE		8		
	WASHER FOR STORM PROTECTION - DICHTSCHEIBE FÜR STURMLEISTE - RONDELLE POUR LAME ANTI-TEMPETE		8		
	ZN NAIL FOR ROOF - ZN NÄGEL FÜR DACHBRETT - POINTE POUR TOIT		278	2x50	
	ZN NAIL FOR FLOOR - ZN NÄGEL FÜR FUSSBODENBRETT - CLOUS POUR PLANCHER		204	2x50	
	SET OF DOOR LOCK COVERS - SCHLOSSBLENDEN - SET DE GARNITURES DE SERRURE DE PORTE		1		
	DOOR HANDLE FITTINGS-TÜRGRIF - SET DE GARNITURES DE SERRURE DE PORTE		1		
	CYLINDER LOCK -ZYLINDERSCHLOSS - CYLINDRE DE SERRURE		1		

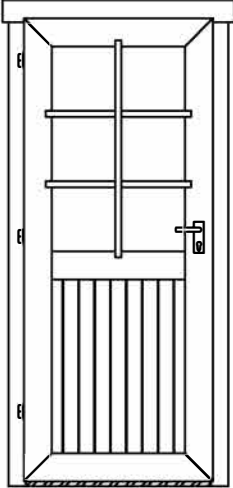
Pos	27.10.2010	6/6	Q.	P (mm)	L (mm)
	<p data-bbox="199 136 624 165">WINDOW-FENSTER-FENETRE 882x882</p> 	AK.1.109.SSV.b	1		
	<p data-bbox="199 472 520 501">DOOR-TÜR-PORTE 835x1850</p> 	UK.2.056.SVV.MMa	1		