

Esra A

1/8

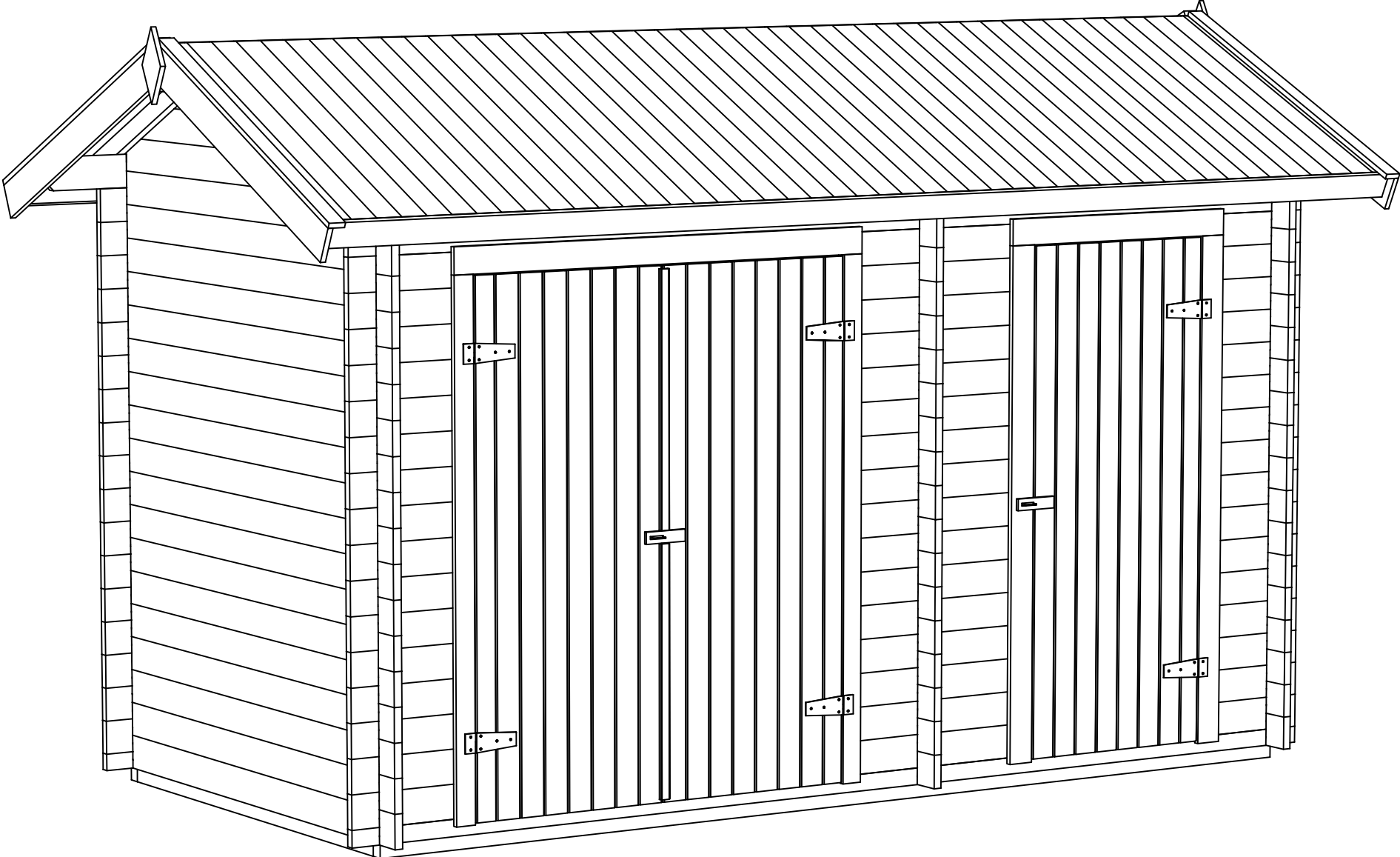

GROUNDPLAN - GRUNDPLAN - PLAN DE MASSE

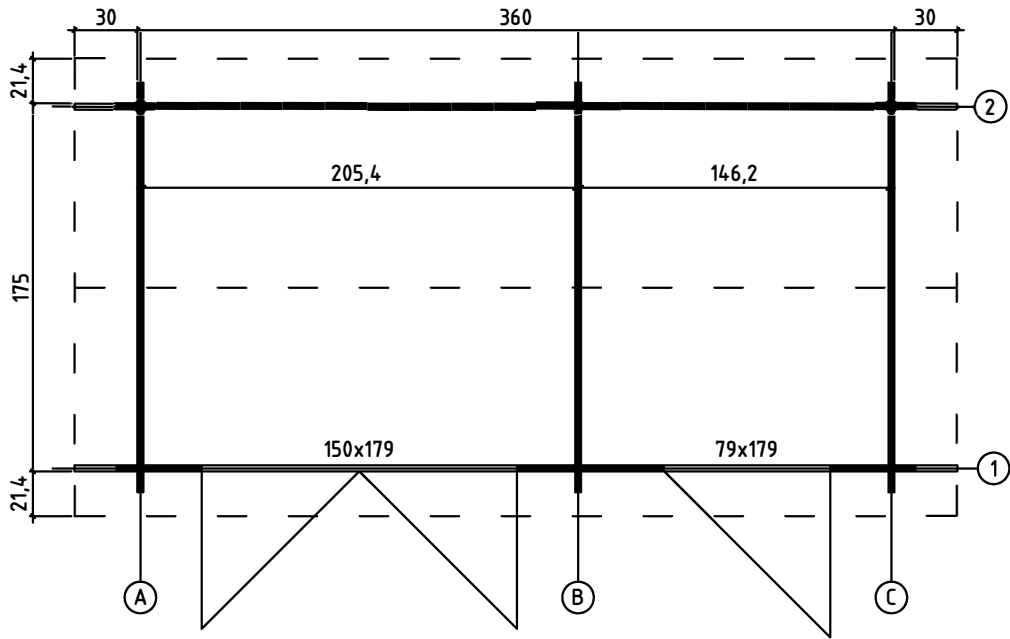

FOUNDATION - FUNDAMENT - FONDATION

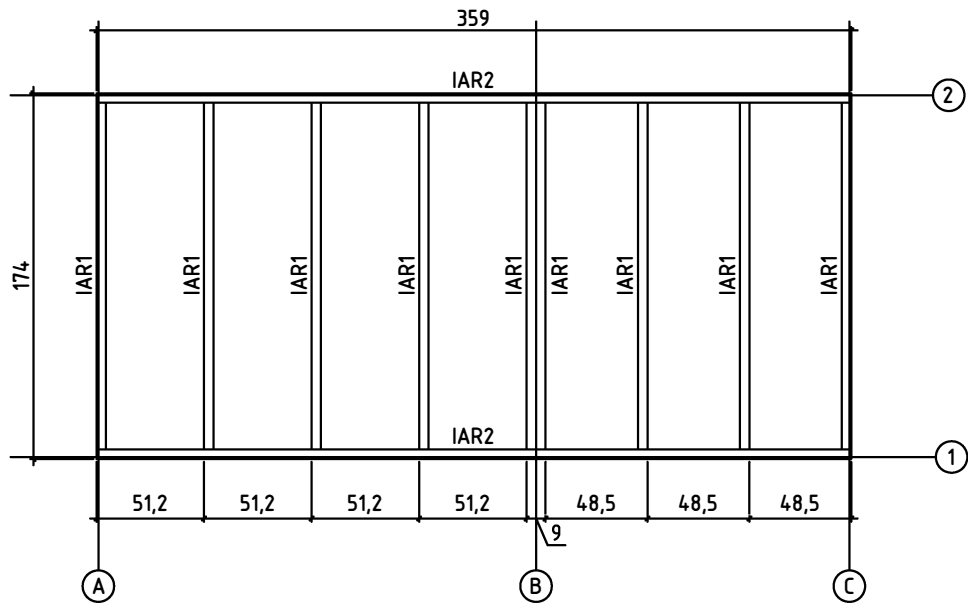

FLOOR BOARDS - FUSSBODENBRETTER - PLAN POSE PLANCHER

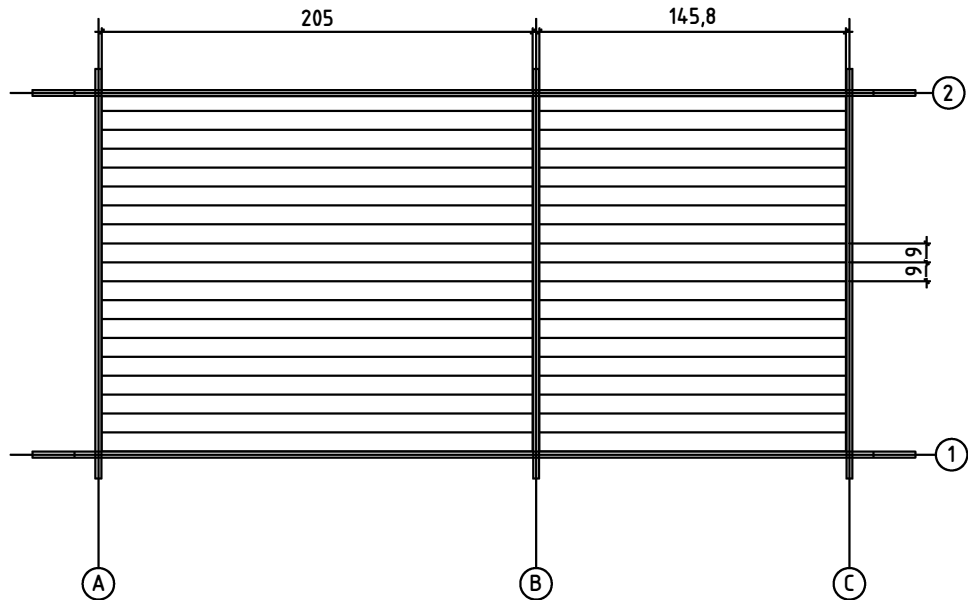

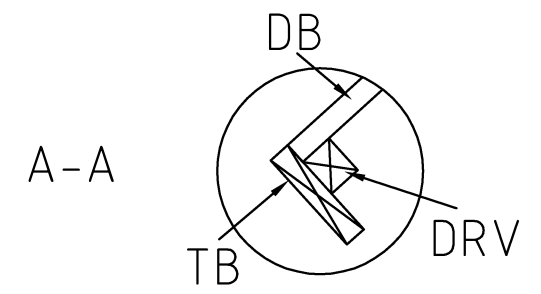
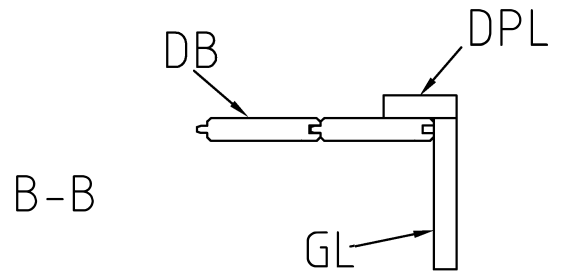
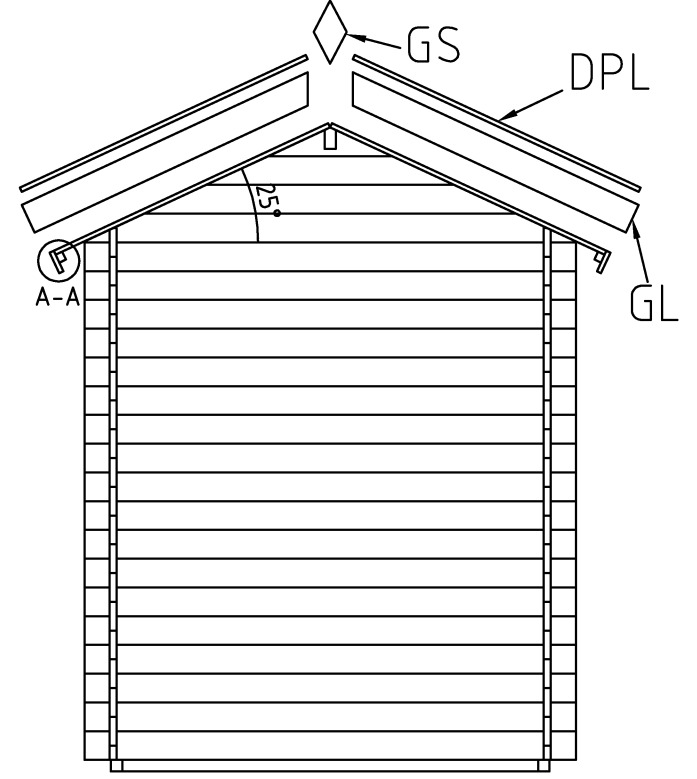
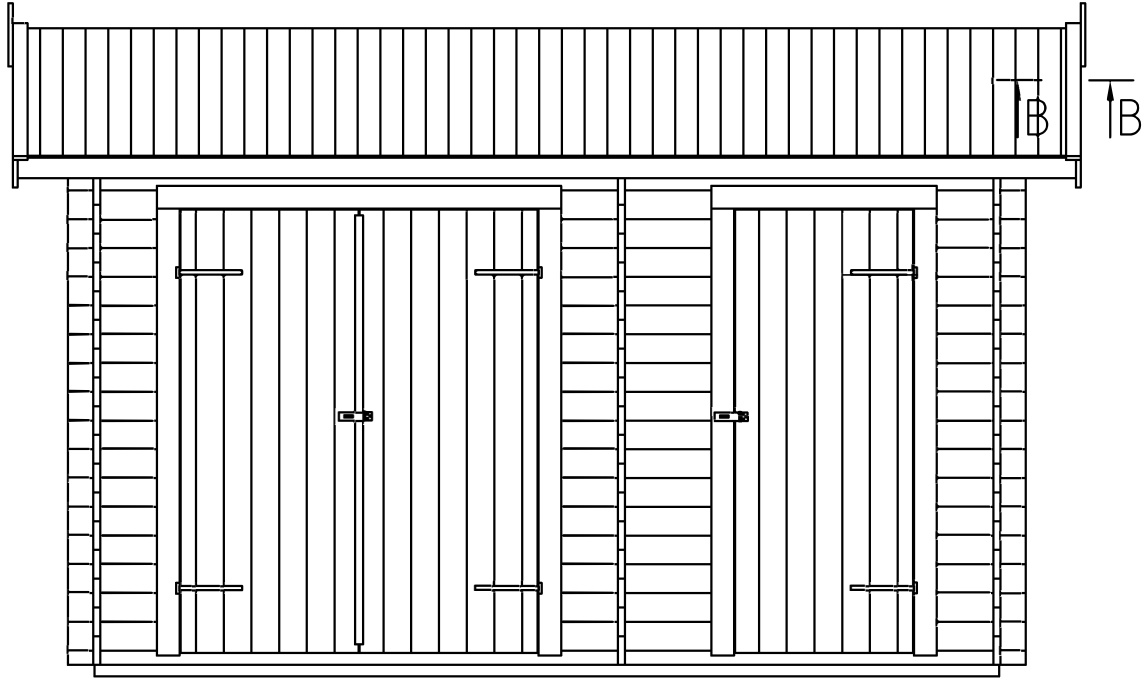



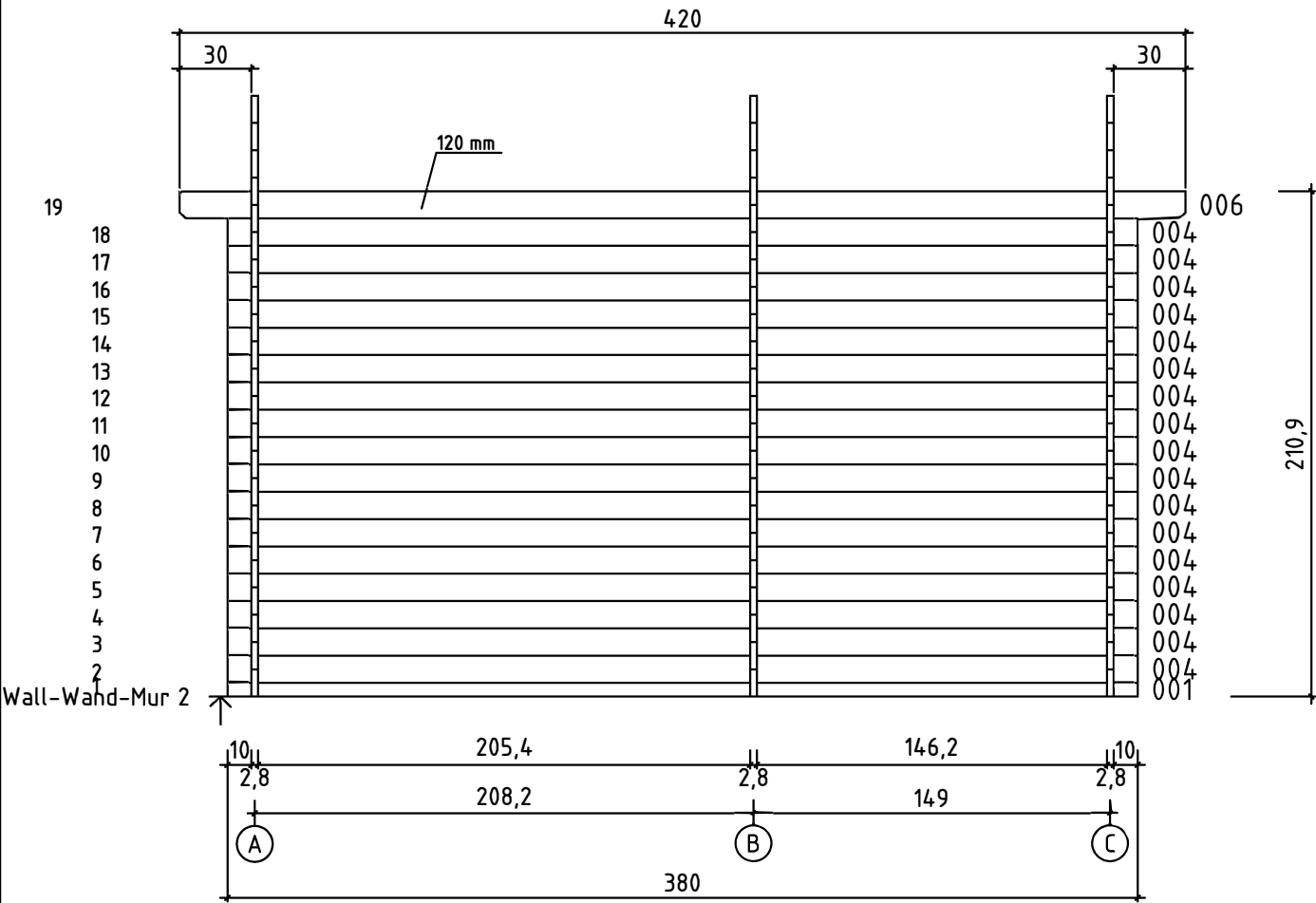
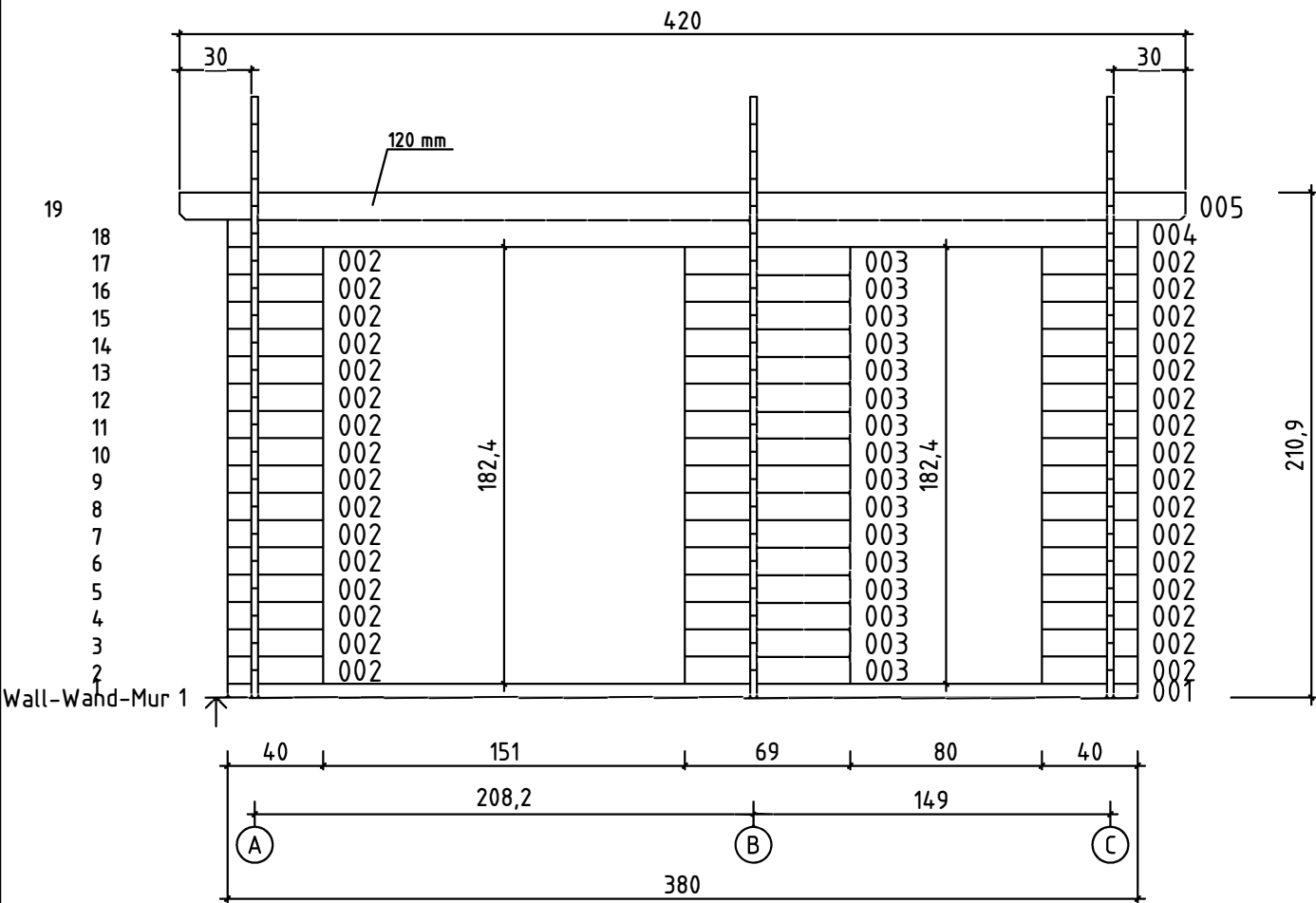

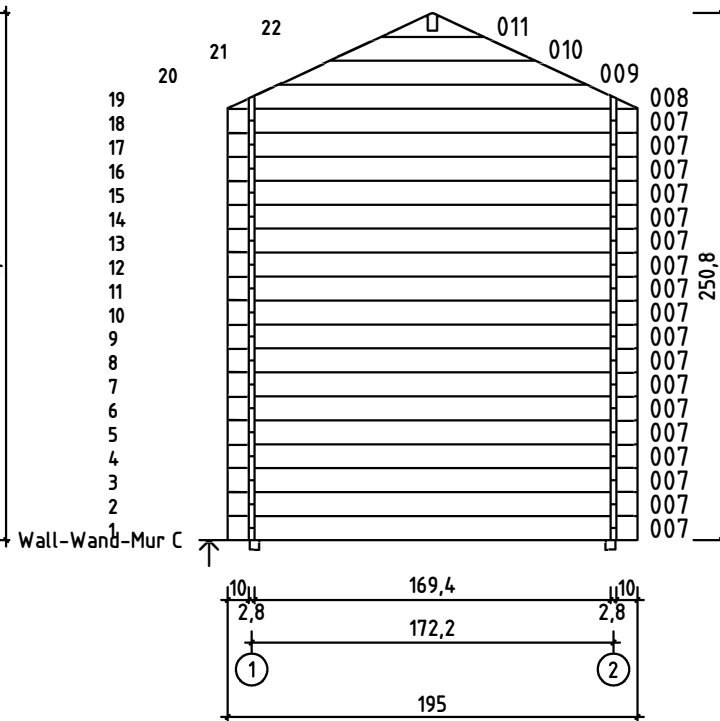
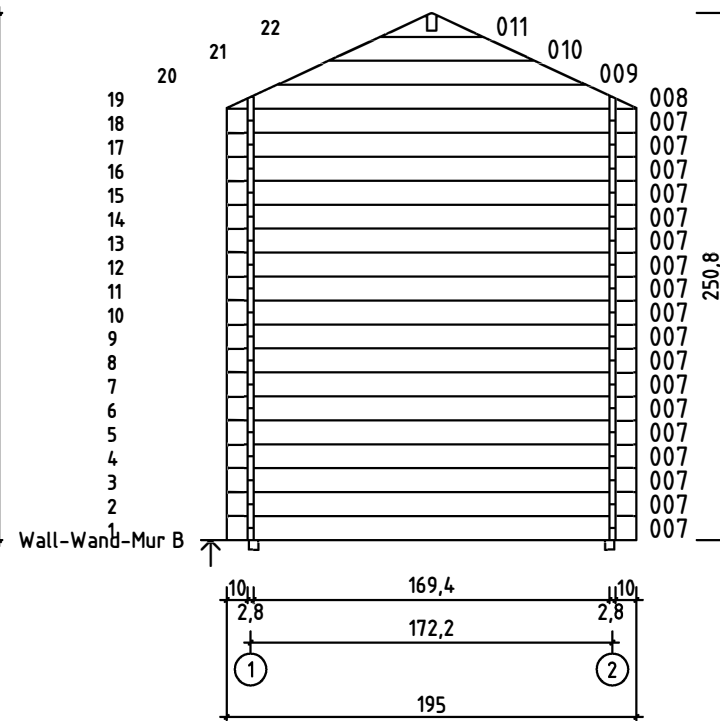
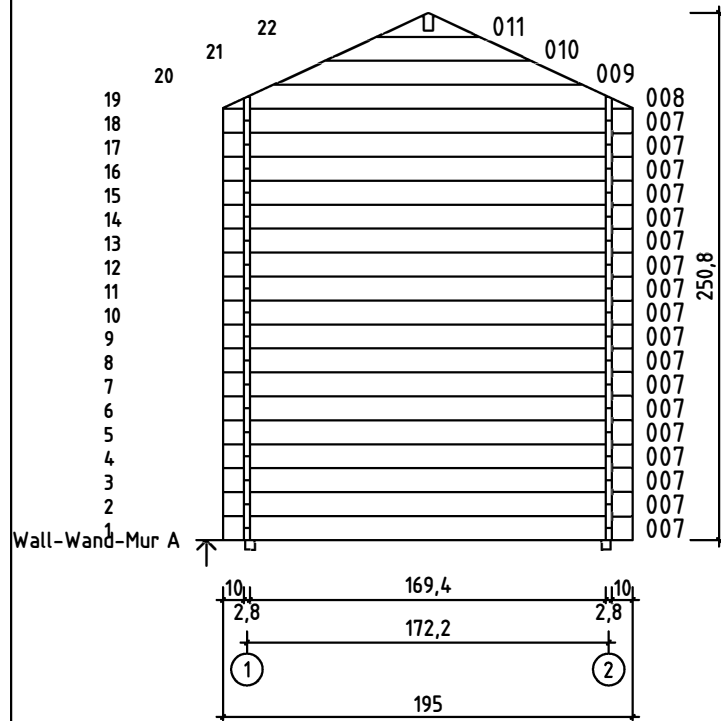
27.05.2013



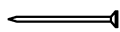
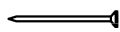
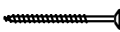
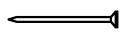
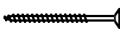
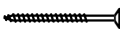
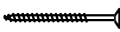
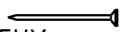
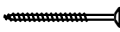
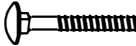

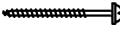
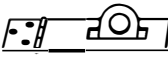
Pos	27.05.2013	Piecelist - Stücklist - Liste des composants	6/8	Q.	P. (mm)	L. (mm)
001				2	28x57	3800
002				32	28x114	400
003				16	28x114	690
004				18	28x114	3800
005				1	28x120	4200
006				1	28x120	4200
007				54	28x114	1950
WA-1 WB-1 WC-1				3		
IAR1	 FOUNDATION - FUNDAMENT - FONDATION			9	45x45	1650
IAR2	 FOUNDATION - FUNDAMENT - FONDATION			2	45x45	3590
PR1	 ROOF BEAM - DACHBALKEN - PANNE DE TOIT			1	44x140	4200
	FLOOR BOARDS - FUSSBODENBRETTER - LAME DE PLANCHER			19	90x18	2050
	FLOOR BOARDS - FUSSBODENBRETTER - LAME DE PLANCHER			19	90x18	1458
DB	ROOF BOARDS - DACHBRETTER - VOLIGES			94	90x18	1200
	FLOOR FILLET-FUSSBODENLEISTE - CORNIERE DE FINITION DU PLANCHER				18x18	13.78
DPL	ROOFING FELT FILLET - DACHPAPPENLEISTE - - BAGUETTE DE FIXATION DU FEUTRE BITUMEUX			4	18x58	1250
TB	EAVES BOARD - TRAUFBRETT - BANDEAU DE TOIT			2	18x90	4200
DRV	ROOF EDGE REINFORCEMENT - DACHRANDVERSTÄRKUNG - - CORNIERE DE RENFORT DE BORD DE TOIT			2	28x34	4200
	STORM PROTECTION - STURMLEISTE - - LATTE ANTI-TEMPETE			4	22x45	2100
GL	GABLE MOULDING - GIEBELLEISTE - - PLANCHE DE RIVE			4	18x120	1250
GS	GABLE SEGMENT-DECKBLATT - LOSANGE DE FINITION			2		
	HAMMER BLOCK - SCHLAGHOLZ - CALLE DE FRAPPE 28mm			1		300
	SCREW FOR FUNDAMENT - SCHRAUBEN ZUR BEFESTIGUNG FUNDAMENT - - VIS POUR FONDATION			19	5x90	
	SCREW FOR 1. WALL BEAM - SCHRAUBE FÜR 1. BOHLENREIHE - - VIS DE FIXATION DES FONDATIONS			6	5x90	

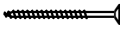
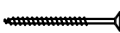
Pos	27.05.2013	Piecelist - Stücklist - Liste des composants	7/8	Q.	P. (mm)	L. (mm)
		ZN NAIL FOR FLOOR - ZN NÄGEL FÜR FUSSBODENBRETTER - - CLOUS POUR PLANCHER		180	2x50	
		ZN NAIL FOR FLOOR FILLET - ZN NÄGEL FÜR FUSSBODENLEISTE - - POINTE POUR CORNIERE DE FINITION DU PLANCHER		28	1.4x40	
		SCREW FOR ROOF BEAMS - SCHRAUBEN FÜR DACHBALKEN - - VIS POUR PANNE DE TOIT		9	5x120	
		ZN NAIL FOR ROOF - ZN NÄGEL FÜR DACHBRETTER - - POINTE POUR TOIT		196	2x50	
		SCREW FOR EAVES BOARDS - SCHRAUBEN FÜR TRAUFBRETTER - - VIS DE FIXATION POUR BANDEAU DE TOIT		18	4x40	
		SCREW FOR ROOF EDGE REINFORCEMENT - SCHRAUBEN FÜR DACHRANDVERSTÄRKUNG - VIS POUR RENFORT DE BORD DE TOIT		18	4x40	
		SCREW FOR GABLE MOULDING - SCHRAUBEN FÜR GIEBELLEISTE - - VIS DE FIXATION POUR PLANCHE DE RIVE		16	3.5x50	
		ZN NAIL FOR ROOFING FELT FILLET - ZN NÄGEL FÜR DACHPAPPENLEISTE - POINTE POUR BAGUETTE FIXATION FEUTRE BITUMEUX		16	2x40	
		SCREW FOR GABLE SEGMENT - SCHRAUBEN FÜR DECKBLATT - - VIS POUR FIXATION LOSANGE DE FINITION		4	3.5x35	
		BOLT FOR STORM PROTECTION - BOLZEN FÜR STURMLEISTE - - VIS POUR LAME ANTI-TEMPETE		8		
		WASHER FOR STORM PROTECTION - DICHTSCHEIBE FÜR STURMLEISTE - - RONDELLE POUR LAME ANTI-TEMPETE		8		
		NUT FOR STORM PROTECTION - SCHRAUBENMUTTER FÜR STURMLEISTE - ÉCROU POUR LAME ANTI-TEMPETE		8		
		SCREW FOR PADLOCK HASP - SCHRAUBEN FÜR PANZER ÜBERFALLE - - VIS DE FIXATION LOQUET POUR CADENAS		14	3.5x20	
		PADLOCK HASP - PANZER ÜBERFALLE - LOQUET POUR CADENAS		2		115
		HINGE FOR DOOR - TÜRRIEGEL - CHARNIERE DE PORTE		6		230
		SCREW FOR FILLET - SCHRAUBE ZUR BEFESTIGUNG TÜRLEISTE - - VIS D'ASSEMBLAGE DU CADRE DE PORTE		5	3x30	
		SCREW FOR DOOR JAMB - SCHRAUBE FÜR TÜRRAHMEN - - VIS DE FIXATION POUR MONTANT DE PORTE		8	5x90	
		DOOR - TÜR - PORTE 1500x1790				
		TUL.1.100.IVP.Md TZ		1		
		