

Sonja C

1/6

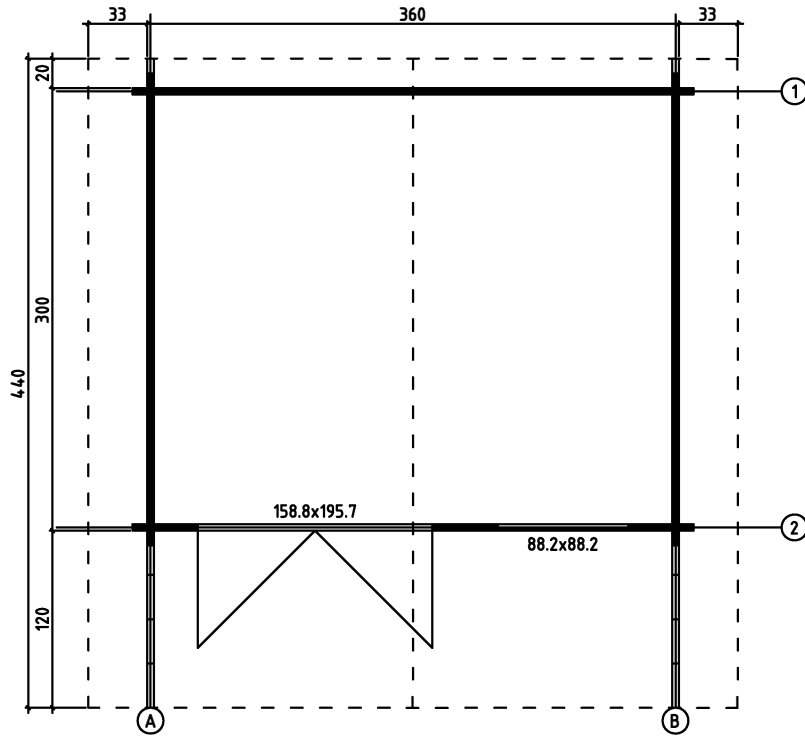

GROUNDPLAN - GRUNDPLAN - PLAN DE MASSE





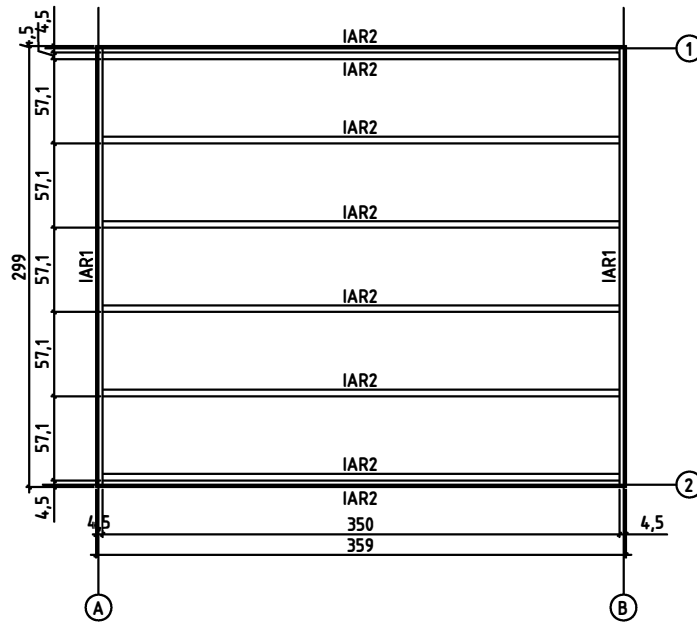



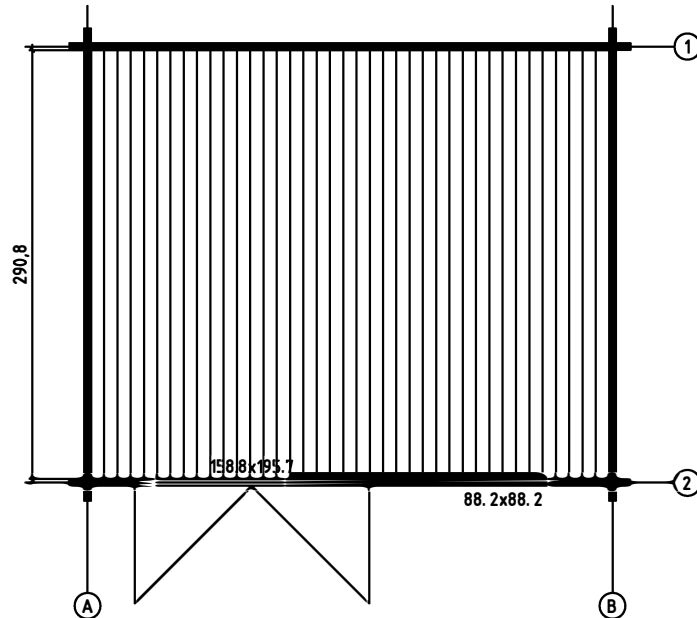

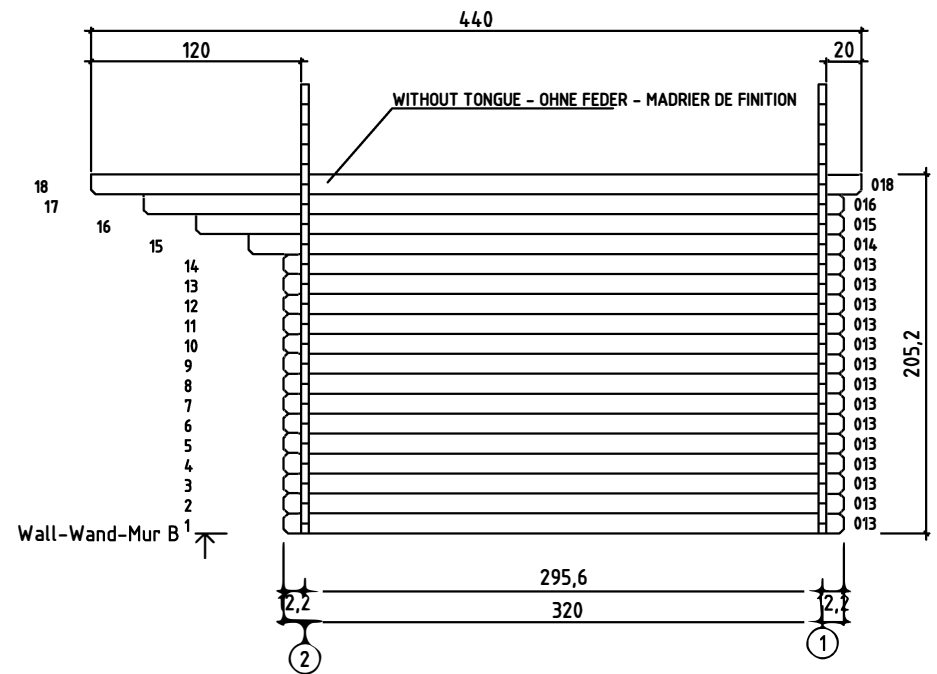
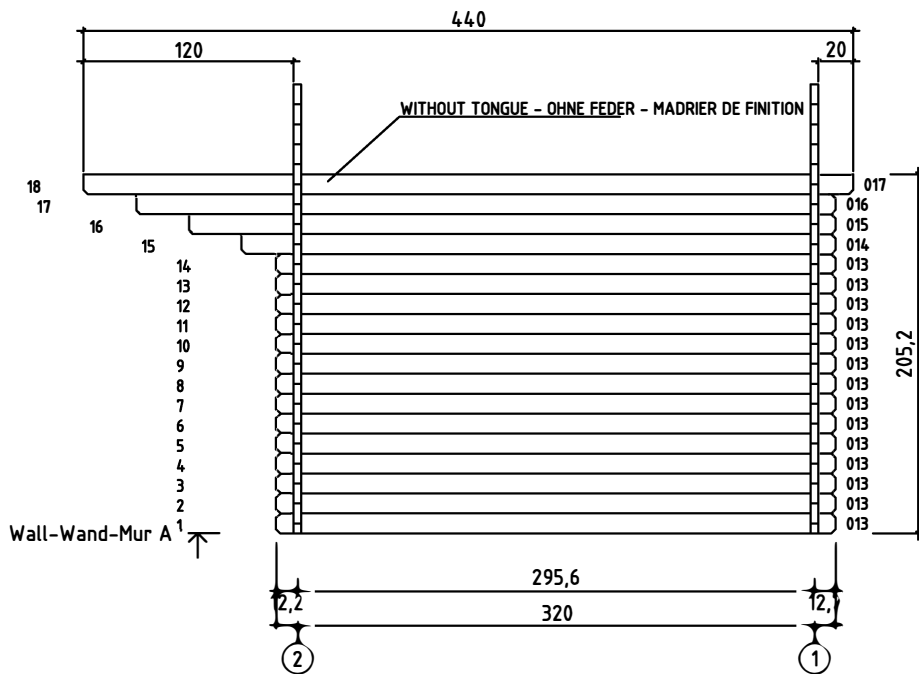
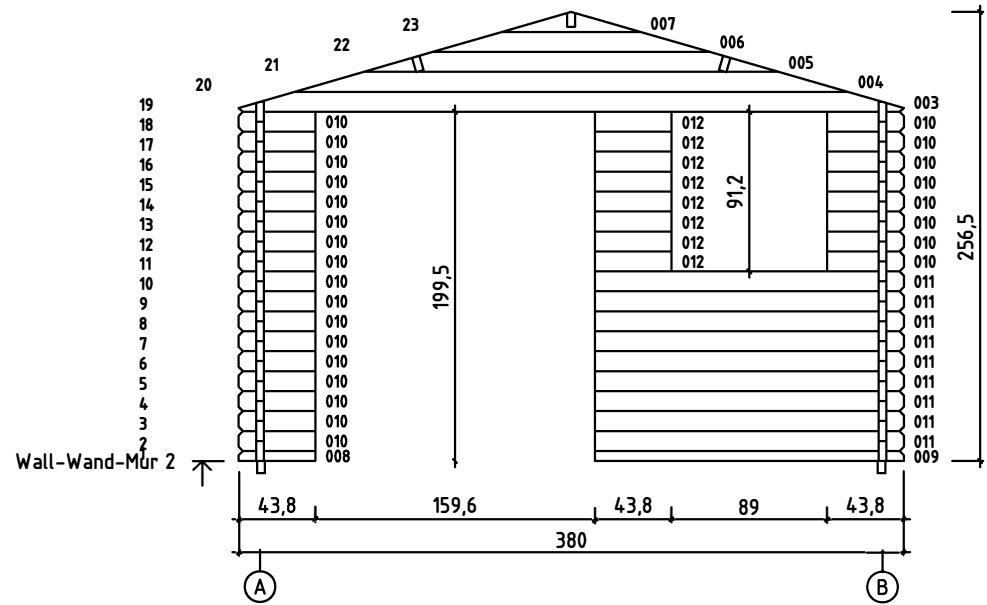
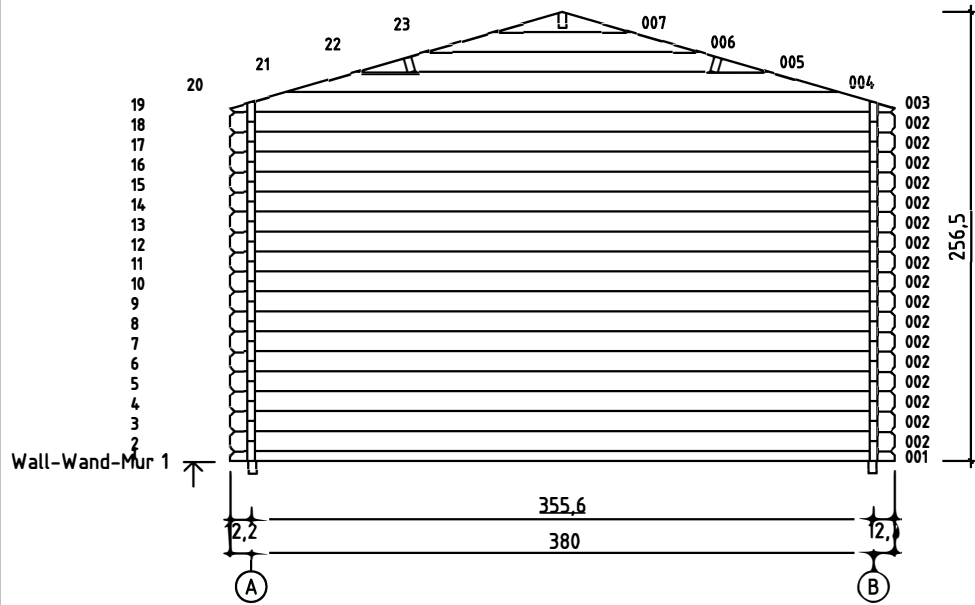

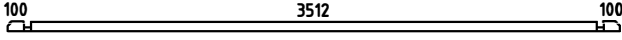
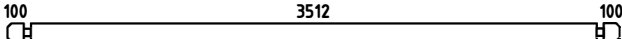

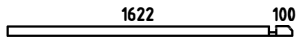

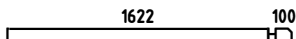
FOUNDATION - FUNDAMENT - FONDATION

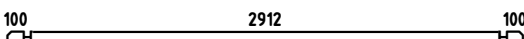
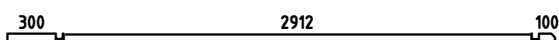

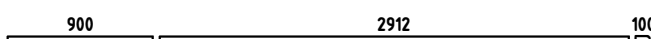

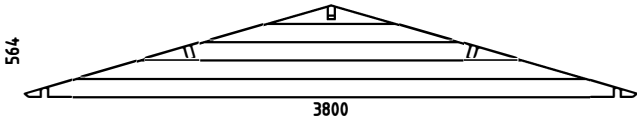
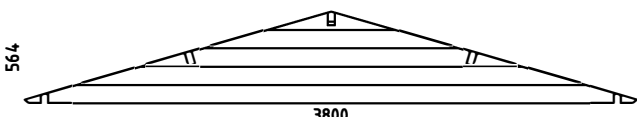

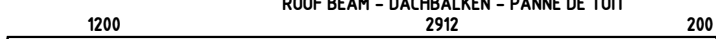
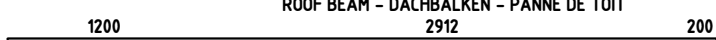
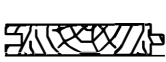

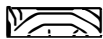



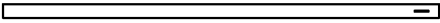
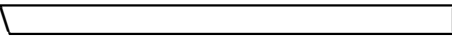

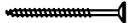
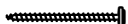







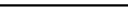
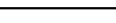

FLOOR BOARDS - FUSSBODENBRETTER - PLAN POSE PLANCHER





Pos	04.01.2011	4/6	St.	Profile (mm)	Lenght (mm)
001			1	44x57	3800
002			17	44x114	3800
008			1	44x57	438
009			1	44x57	1766
010			25	44x114	438
011			9	44x114	1766
012			8	44x114	438
013			28	44x114	3200
014			2	44x114	3400
015			2	44x114	3700
016			2	44x114	4000
017			1	44x120	4400
018			1	44x120	4400
W1-1			1		
W2-1			1		
IAR2	FOUNDATION - FUNDAMENT - FONDATION 		8	45x70	3500
IAR1	FOUNDATION - FUNDAMENT - FONDATION 		2	45x70	2990
PR11	ROOF BEAM - DACHBALKEN - PANNE DE TOIT 		1	44x140	4400
PR21	ROOF BEAM - DACHBALKEN - PANNE DE TOIT 		2	44x140	4400
	FLOOR BOARDS - FUSSBODENBRETTER - LAME DE PLANCHER 		39	90x18	2908
	ROOF BOARDS - DACHBRETTER - VOLIGES 		98	90x18	2200
	FLOOR FILLET-FUSSBODENLEISTE - CORNIERE DE FINITION DU PLANCHER 			18x18	12.83
	ROOFING FELT FILLET - DACHPAPPENLEISTE - BAGUETTE DE FIXATION DU FEUTRE BITUMEUX 		4	18x58	2250

Pos	04.01.2011	5/6	St.	Profile (mm)	Lenght (mm)
	EAVES BOARD - TRAUFBRETT - BANDEAU DE TOIT		2	18x90	4400
	ROOF EDGE REINFORCEMENT - DACHRANDVERSTÄRKUNG - CORNIERE DE RENFORT DE BORD DE TOIT		2	28x34	4400
	STORM PROTECTION - STURMLEISTE LATTE ANTI-TEMPETE		4	22x45	2000
	GABLE MOULDING - GIEBELLEISTE PLANCHE DE RIVE		4	18x120	2250
	WINDOW HANDLE FITTINGS-FENSTERGRIFF - POIGNÉE D'OUVERTURE DE FENETRE		1		
	SCREW FOR GABLE SEGMENT - SCHRAUBEN FÜR DECKBLATT - VIS POUR FIXATION LOSANGE DE FINITION		4	3.5x35	
	SCREW FOR DOORSTEP - SCHRAUBEN FÜR SWELLE - VIS DE FIXATION DU SEUIL DE PORTE		3	4.5x65	
	SCREW FOR GABLE MOULDING - SCHRAUBEN FÜR GIEBELLEISTE - VIS DE FIXATION POUR PLANCHE DE RIVE		24	3.5x50	
	SCREW FOR DOOR FILLET - SCHRAUBE ZUR BEFESTIGUNG TÜRLEISTE VIS D'ASSEMBLAGE DU CADRE DE PORTE		5	3x30	
	SCREW FOR EAVES BOARDS - SCHRAUBEN FÜR TRAUFBRETT - VIS DE FIXATION POUR BANDEAU DE TOIT		20	4x40	
	SCREW FOR ROOF EDGE REINFORCEMENT - SCHRAUBEN FÜR DACHRANDVERSTÄRKUNG - VIS POUR RENFORT DE BORD DE TOIT		20	4x40	
	SCREW FOR ROOF BEAMS - SCHRAUBEN FÜR DACHBALKEN - VIS POUR PANNE DE TOIT		10	5x120	
	SCREW FOR 1. WALL BEAM - SCHRAUBE FÜR 1. BOHLENREIHE - VIS DE FIXATION DES FONDATIONS		5	5x90	
	SCREW FOR FUNDAMENT - SCHRAUBEN ZUR BEFESTIGUNG FUNDAMENT - VIS POUR FONDATION		18	5x90	
	SCREW FOR DOOR JAMB - SCHRAUBE FÜR TÜRRAHMEN - VIS DE FIXATION POUR MONTANT DE PORTE		4	5x90	
	ZN NAIL FOR FLOOR FILLET - ZN NÄGEL FÜR FUSSBODENLEISTE - POINTE POUR CORNIERE DE FINITION DU PLANCHER		26	1.4x40	
	HAMMER BLOCK - SCHLAGHOLZ - CALLE DE FRAPPE		1		
	ZN NAIL FOR ROOFING FELT FILLET - ZN NÄGEL FÜR DACHPAPPENLEISTE - POINTE POUR BAGUETTE FIXATION FEUTRE BITUMEUX		24	2x40	
	BOLT FOR WINDOW HANDLE FITTINGS - BOLZEN FÜR FENSTERGRIFF BESCHLAG - BOULON POUR POIGNÉE D'OUVERTURE DE FENETRE		2		
	GABLE SEGMENT-DECKBLATT - LOSANGE DE FINITION		2		
	NUT FOR STORM PROTECTION - SCHRAUBENMUTTER FÜR STURMLEISTE - ÉCROU POUR LAME ANTI-TEMPETE		8		
	BOLT FOR STORM PROTECTION - BOLZEN FÜR STURMLEISTE - VIS POUR LAME ANTI-TEMPETE		8		
	WASHER FOR STORM PROTECTION - DICHTSCHEIBE FÜR STURMLEISTE - RONDELLE POUR LAME ANTI-TEMPETE		8		
	ZN NAIL FOR ROOF - ZN NÄGEL FÜR DACHBRETT - POINTE POUR TOIT		310	5x50	
	ZN NAIL FOR FLOOR - ZN NÄGEL FÜR FUSSBODENBRETT - CLOUS POUR PLANCHER		240	2x50	

