

Carla
1/8

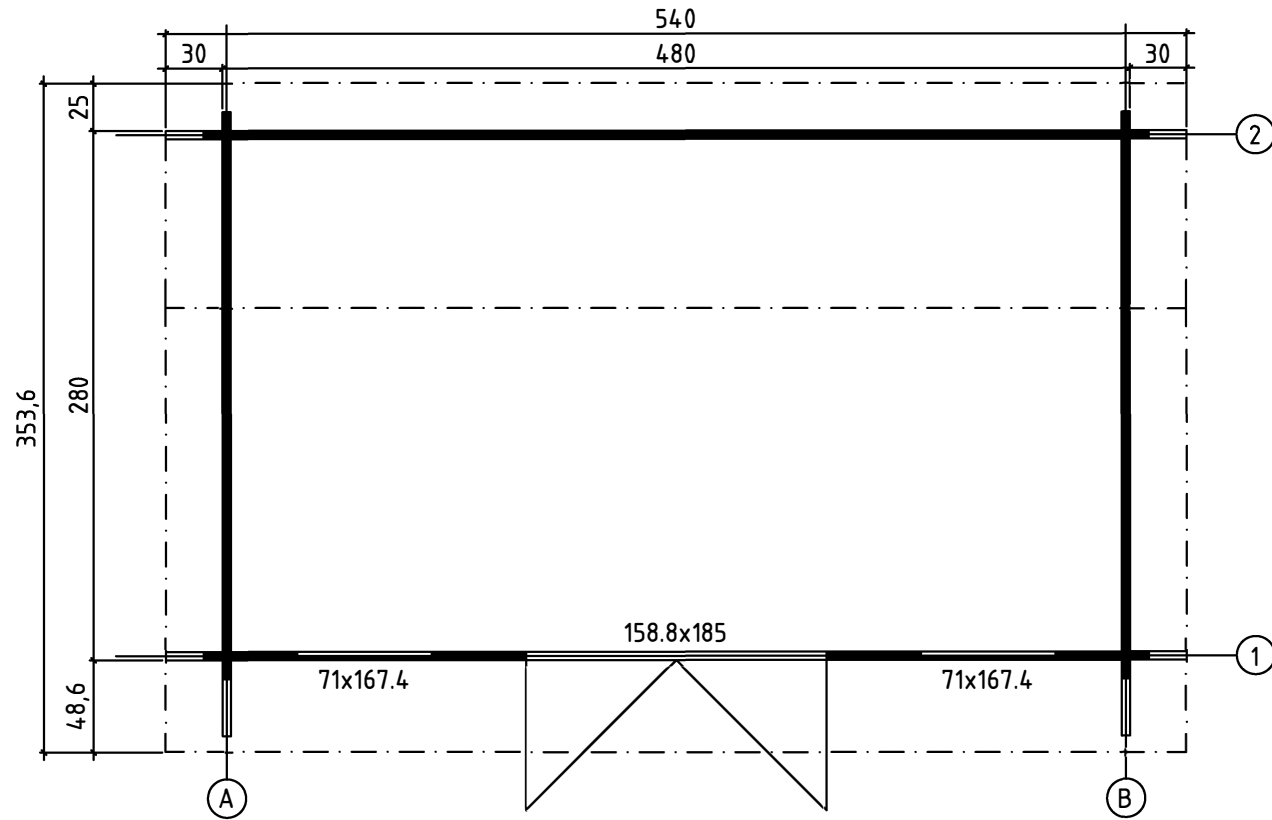

30.06.2016

GROUNDPLAN - GRUNDPLAN - PLAN DE MASSE





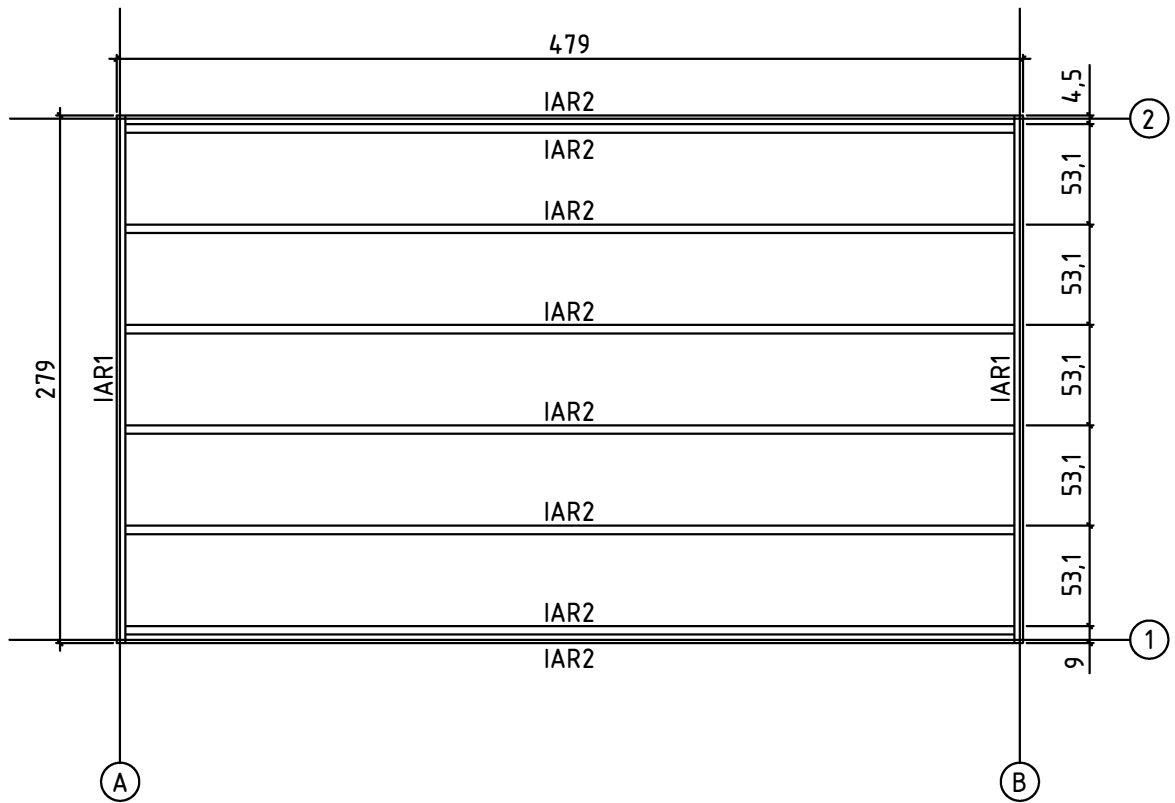



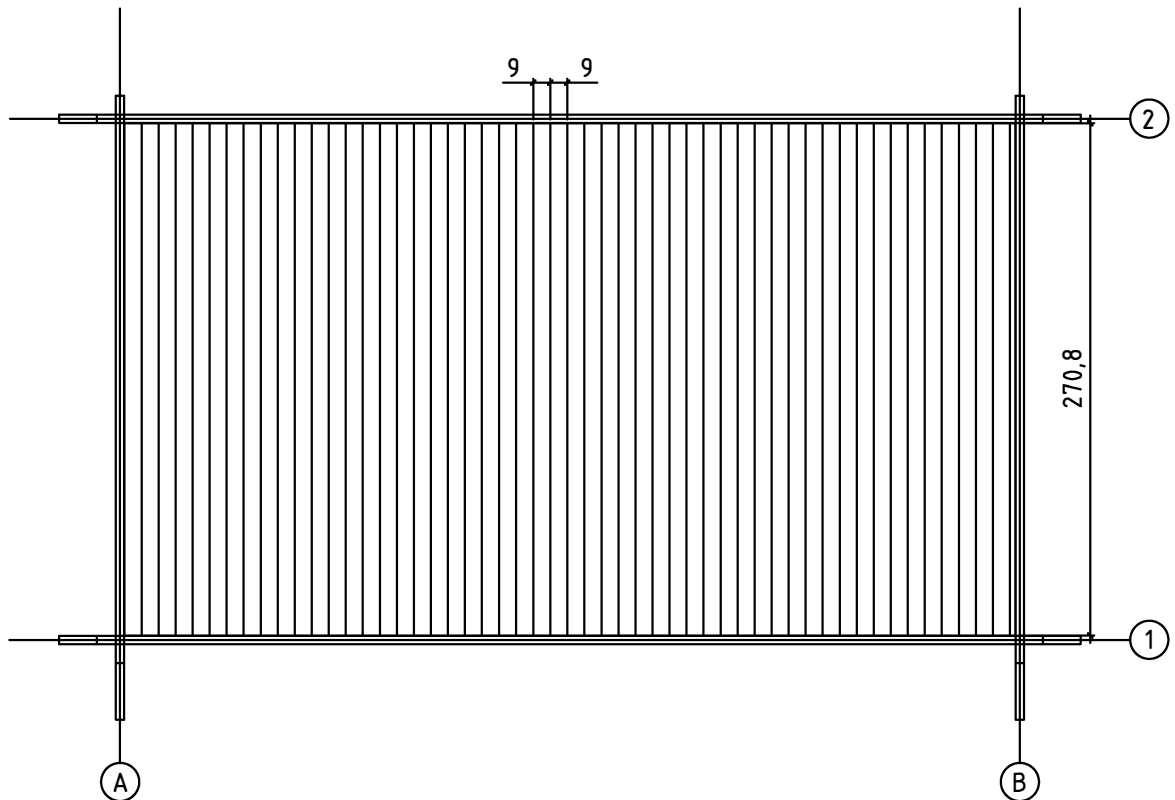

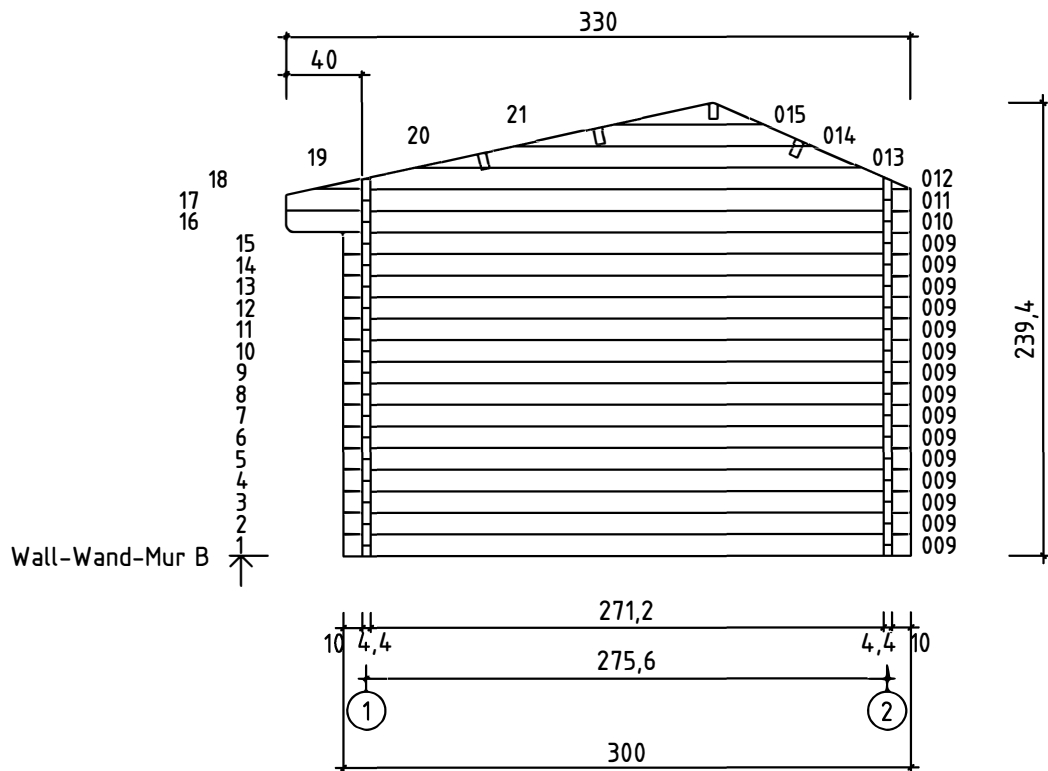
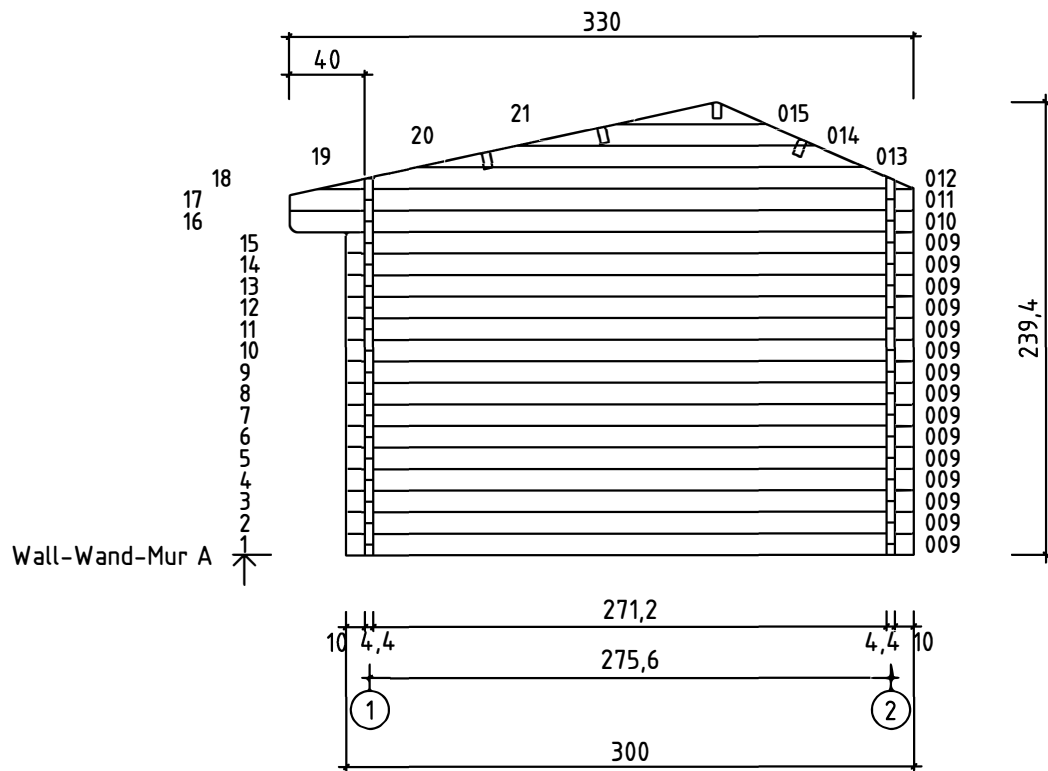
FOUNDATION - FUNDAMENT - FONDATION

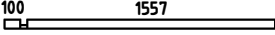
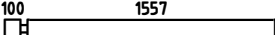

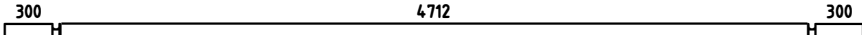
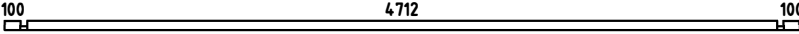
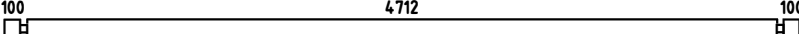
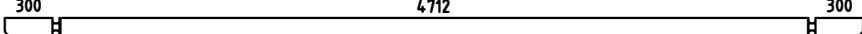
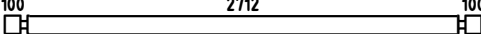
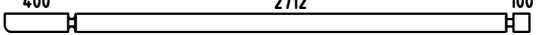
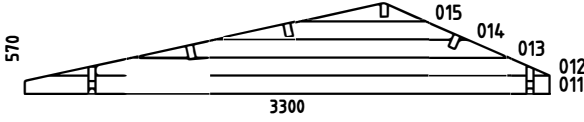
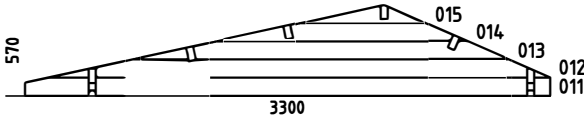
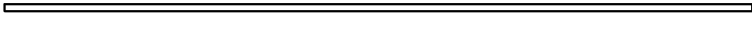
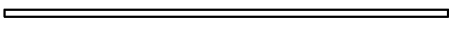
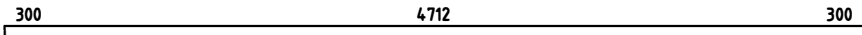
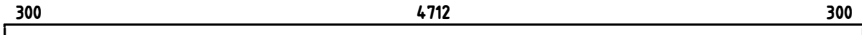



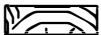
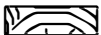





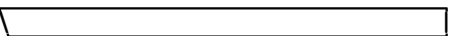
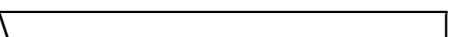

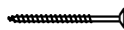

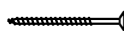
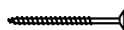
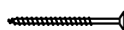
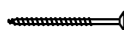

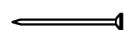
FLOOR BOARDS - FUSSBODENBRETTER - PLAN POSE PLANCHER

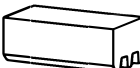
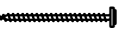
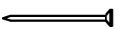
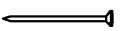
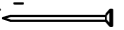

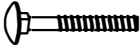

Pos	30.06.2016	Piece list - Stückliste - Liste des pièces	6/8	Q.	P (mm)	L (mm)
001				2	44x57	1701
002				2	44x114	1701
003				30	44x114	491
004				30	44x114	491
005				1	44x120	5400
006				1	44x57	5000
007				16	44x114	5000
008				1	44x120	5400
009				30	44x114	3000
010				2	44x114	3300
WA-1				1		
WB-1				1		
IAR2	FOUNDATION - FUNDAMENT - FONDATION 			8	45x45	4700
IAR1	FOUNDATION - FUNDAMENT - FONDATION 			2	45x45	2790
PR1	ROOF BEAM - DACHBALKEN - PANNE DE TOIT 			1	44x140	5400
A-PR1	ROOF BEAM - DACHBALKEN - PANNE DE TOIT 			3	44x140	5400
	FLOOR BOARDS - FUSSBODENBRETTER - LAME DE PLANCHER			53	90x18	2708
	ROOF BOARDS - DACHBRETTER - VOLIGES			60	90x18	2400
	ROOF BOARDS - DACHBRETTER - VOLIGES			60	90x18	1300
FL	FLOOR FILLET-FUSSBODENLEISTE - CORNIERE DE FINITION DU PLANCHER				18x18	14.83
DPL	ROOFING FELT FILLET - DACHPAPPENLEISTE - BAGUETTE DE FIXATION DU FEUTRE BITUMEUX			2	18x58	1350
DPL	ROOFING FELT FILLET - DACHPAPPENLEISTE - BAGUETTE DE FIXATION DU FEUTRE BITUMEUX			2	18x58	2450
TB	EAVES BOARD - TRAUFBRETT - BANDEAU DE TOIT			4	18x58	2700

Pos	30.06.2016	Piece list - Stückliste - Liste des pièces	7/8	Q.	P (mm)	L (mm)
DRV		ROOF EDGE REINFORCEMENT - DACHRANDVERSTÄRKUNG - CORNIERE DE RENFORT DE BORD DE TOIT		4	28x34	2700
KFS		STORM PROTECTION - STURMLEISTE - LATTE ANTI-TEMPETE		4	22x45	2050
GL		GABLE MOULDING - GIEBELLEISTE - PLANCHE DE RIVE		2	18x120	1350
GL		GABLE MOULDING - GIEBELLEISTE - PLANCHE DE RIVE		2	18x120	2450
FS		WINDOW HANDLE FITTINGS-FENSTERGRIFF - POIGNÉE D'OUVERTURE DE FENETRE		2		
HS43		SCREW FOR ROOF BEAMS - SCHRAUBEN FÜR DACHBALKEN - VIS POUR PANNE DE TOIT		12	5x120	
HS40		SCREW FOR 1. WALL BEAM - SCHRAUBE FÜR 1. BOHLENREIHE - VIS DE FIXATION DES FONDATIONS		8	5x90	
HS41		SCREW FOR DOOR JAMB - SCHRAUBE FÜR TÜRRAHMEN - VIS DE FIXATION POUR MONTANT DE PORTE		4	5x90	
		SCREW FOR GABLE SEGMENT - SCHRAUBEN FÜR DECKBLATT - VIS POUR FIXATION LOSANGE DE FINITION		4	3.5x50	
		SCREW FOR GABLE MOULDING - SCHRAUBEN FÜR GIEBELLEISTE - VIS DE FIXATION POUR PLANCHE DE RIVE		28	3.5x50	
		SCREW FOR DOOR FILLET - SCHRAUBE ZUR BEFESTIGUNG TÜRLEISTE - VIS D'ASSEMBLAGE DU CADRE DE PORTE		5	3x30	
		SCREW FOR EAVES BOARDS - SCHRAUBEN FÜR TRAUFBRETTER - VIS DE FIXATION POUR BANDEAU DE TOIT		24	4x40	
		SCREW FOR FUNDAMENT - SCHRAUBEN ZUR BEFESTIGUNG FUNDAMENT - VIS POUR FONDATION		16	5x90	
		SCREW FOR FUNDAMENT - SCHRAUBEN ZUR BEFESTIGUNG FUNDAMENT - VIS POUR FONDATION		8	5x90	
NFF		ZN NAIL FOR FLOOR FILLET - ZN NÄGEL FÜR FUSSBODENLEISTE - POINTE POUR CORNIERE DE FINITION DU PLANCHER		30	1.4x40	
		DOOR HANDLE FITTINGS-TÜRGRIFF - SET DE GARNITURES DE SERRURE DE PORTE		1		
SH44		HAMMER BLOCK - SCHLAGHOLZ - CALLE DE FRAPPE		1		
		SCREW FOR DOORSTEP - SCHRAUBEN FÜR SWELLE - - VIS DE FIXATION DU SEUIL DE PORTE		3	4.5x65	
		ZN NAIL FOR ROOF - ZN NÄGEL FÜR DACHBRETTER - POINTE POUR TOIT		377	2x50	
		ZN NAIL FOR FLOOR - ZN NÄGEL FÜR FUSSBODENBRETTER - CLOUS POUR PLANCHER		324	2x50	
		ZN NAIL FOR ROOFING FELT FILLET - ZN NÄGEL FÜR DACHPAPPENLEISTE - POINTE POUR BAGUETTE FIXATION FEUTRE BITUMEUX		20	2x40	
		MALE BOLT HINGE FOR DOOR - TÜRRIEGEL - - PARTIE MALE DE CHARNIERE DE PORTE		6		
		SCREW FOR ROOF EDGE REINFORCEMENT - SCHRAUBEN FÜR DACHRANDVERSTÄRKUNG - VIS POUR RENFORT DE BORD DE TOIT		24	4x40	
GS		GABLE SEGMENT-DECKBLATT - LOSANGE DE FINITION		2		
		NUT FOR STORM PROTECTION - SCHRAUBENMUTTER FÜR STURMLEISTE - ÉCROU POUR LAME ANTI-TEMPETE		8		

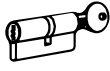
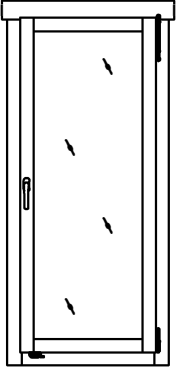
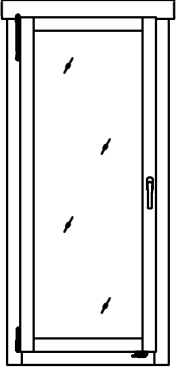
Pos	30.06.2016	Piece list - Stückliste - Liste des pièces	8/8	Q.	P (mm)	L (mm)
BFS	BOLT FOR STORM PROTECTION - BOLZEN FÜR STURMLEISTE - VIS POUR LAME ANTI-TEMPETE			8		
DFS	WASHER FOR STORM PROTECTION - DICHTSCHEIBE FÜR STURMLEISTE - RONDELLE POUR LAME ANTI-TEMPETE			8		
	DOOR HANDLE FITTINGS-TÜRGRIFF - SET DE GARNITURES DE SERRURE DE PORTE			1		
TS6	CYLINDER LOCK -ZYLINDERSCHLOSS - CYLINDRE DE SERRURE			1	30x35	
	WINDOW - FENSTER - FENETRE 710x1674	AK.1.100.PSP.p	DGP+	1		
						
	WINDOW - FENSTER - FENETRE 710x1674	AK.1.100.PSV.p	DGP+	1		
						
	DOOR - TÜR - PORTE 1588x1850	TUK.1.100.PVV.MMa	DGP+	1		
	