

Åke
1/10

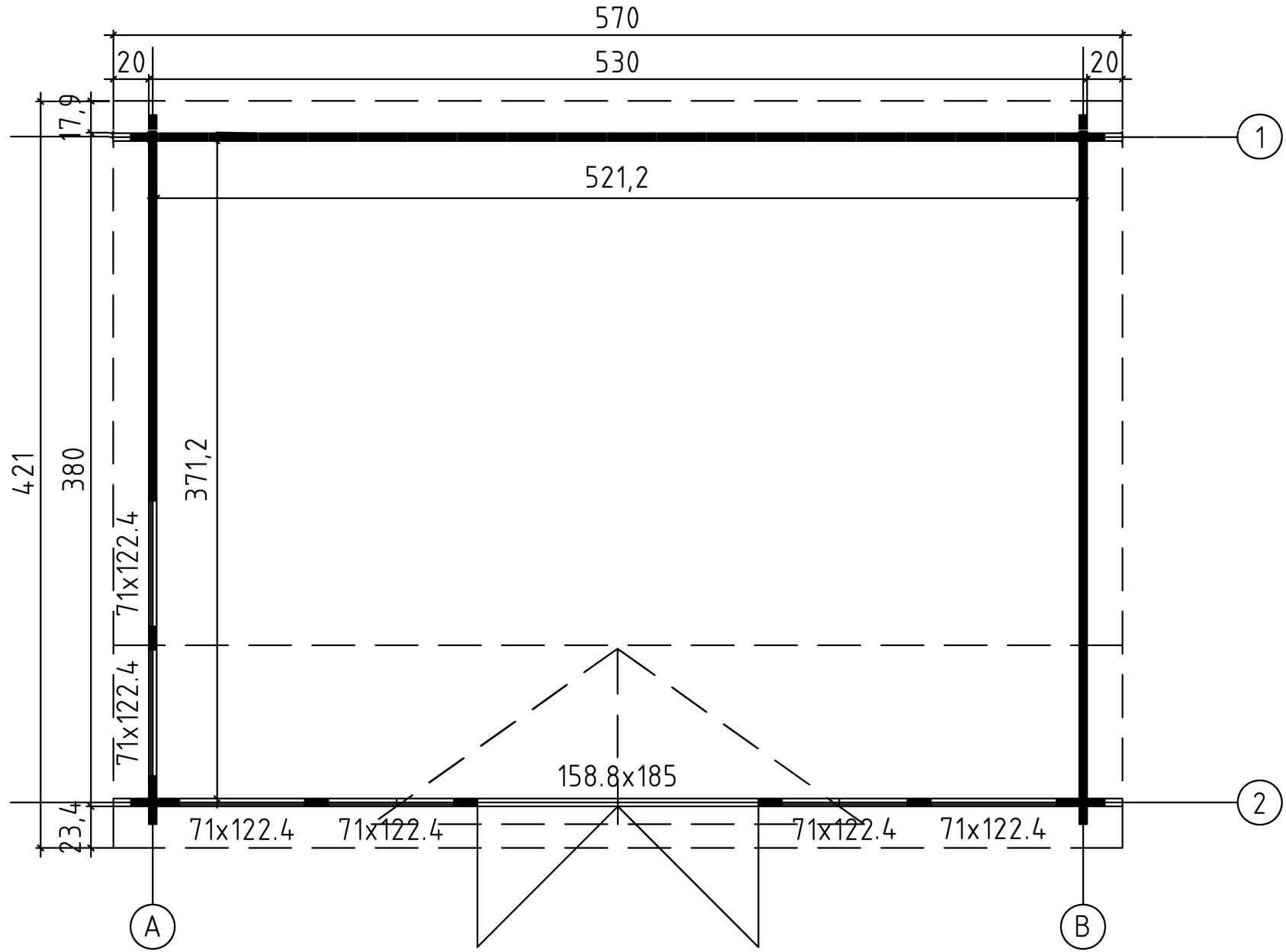

6.04.2016

GROUNDPLAN - GRUNDPLAN - PLAN DE MASSE



FOUNDATION - FUNDAMENT - FONDATION

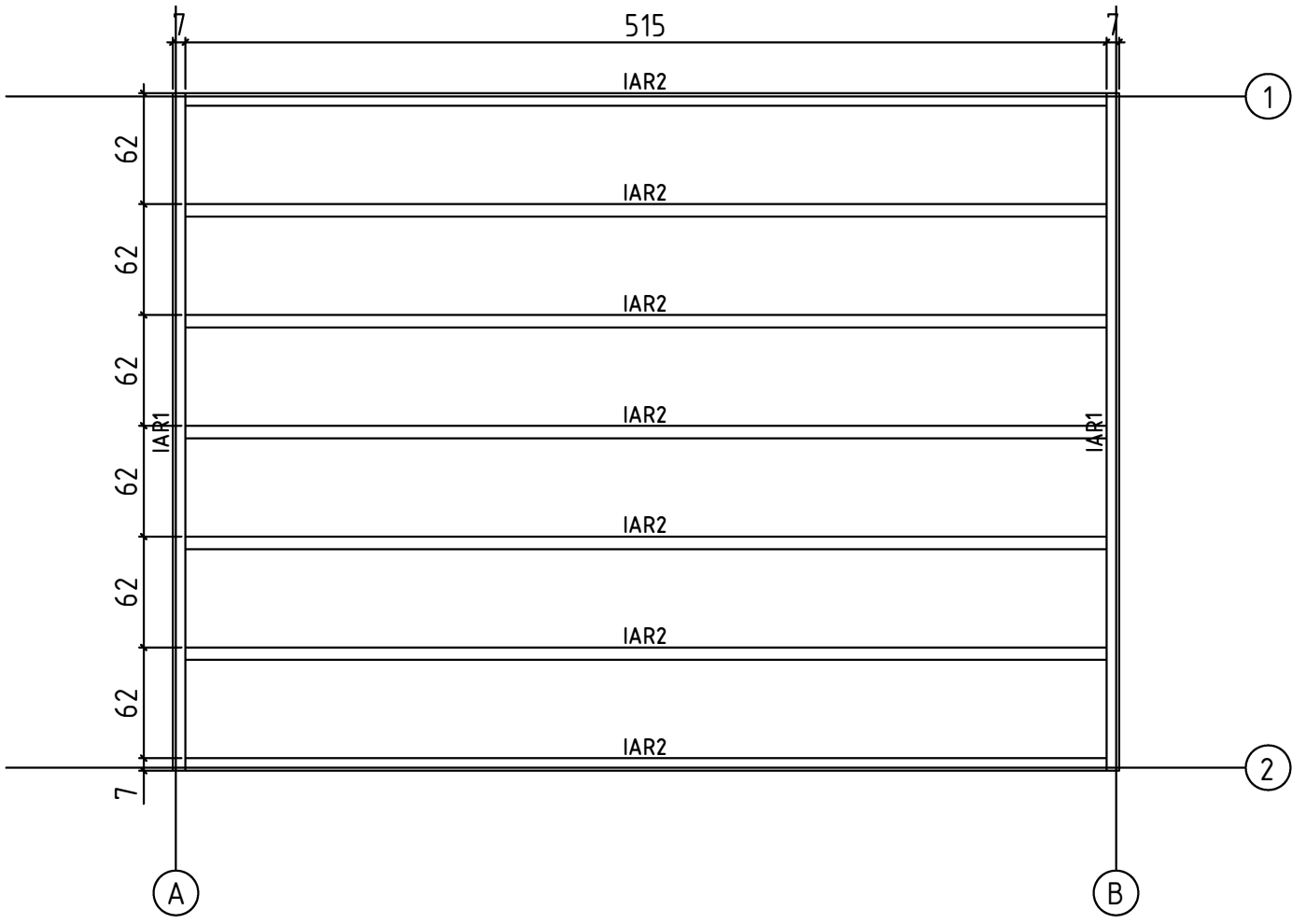

FLOOR BOARDS - FUSSBODENBRETTER - LAME DE PLANCHER

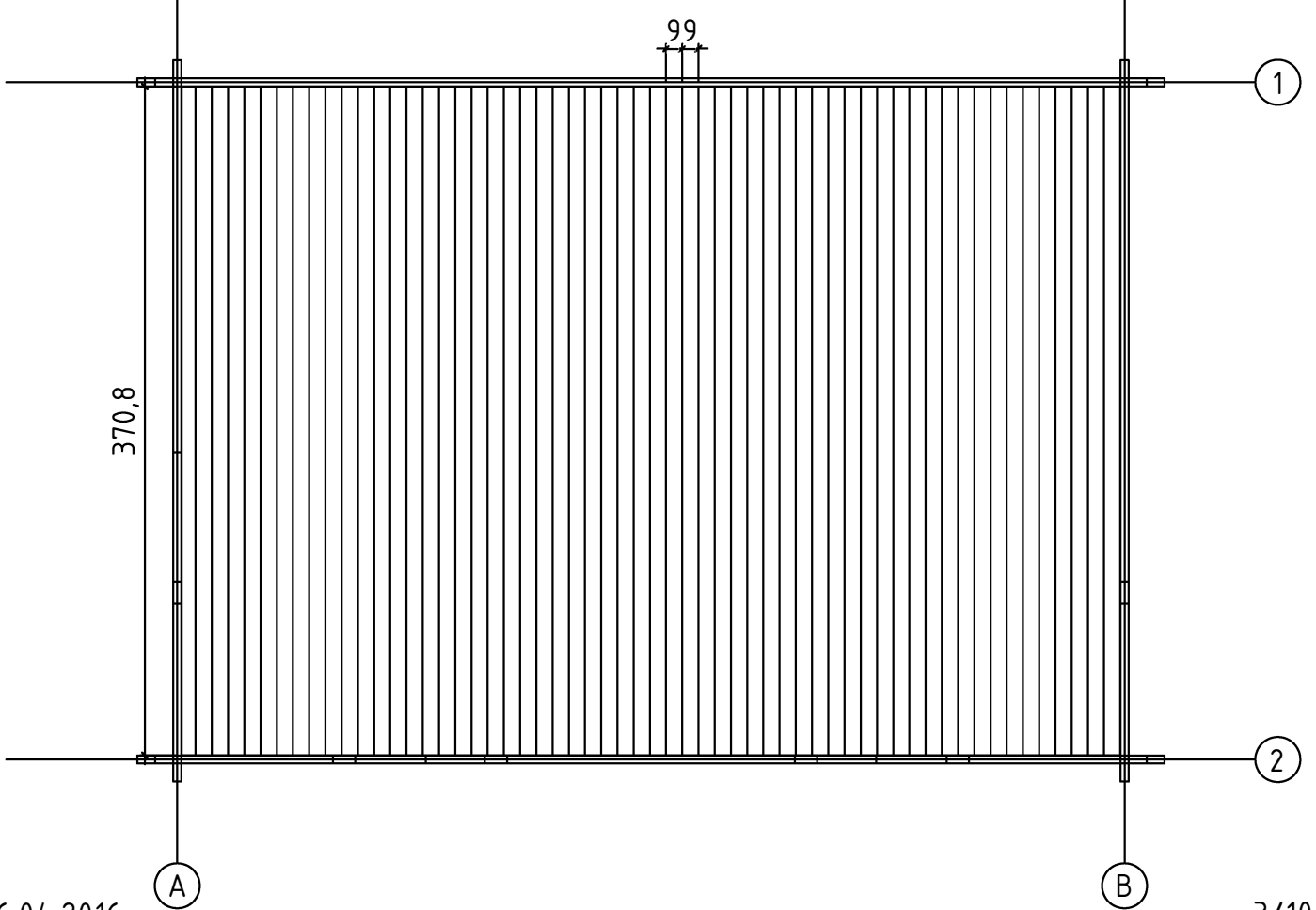

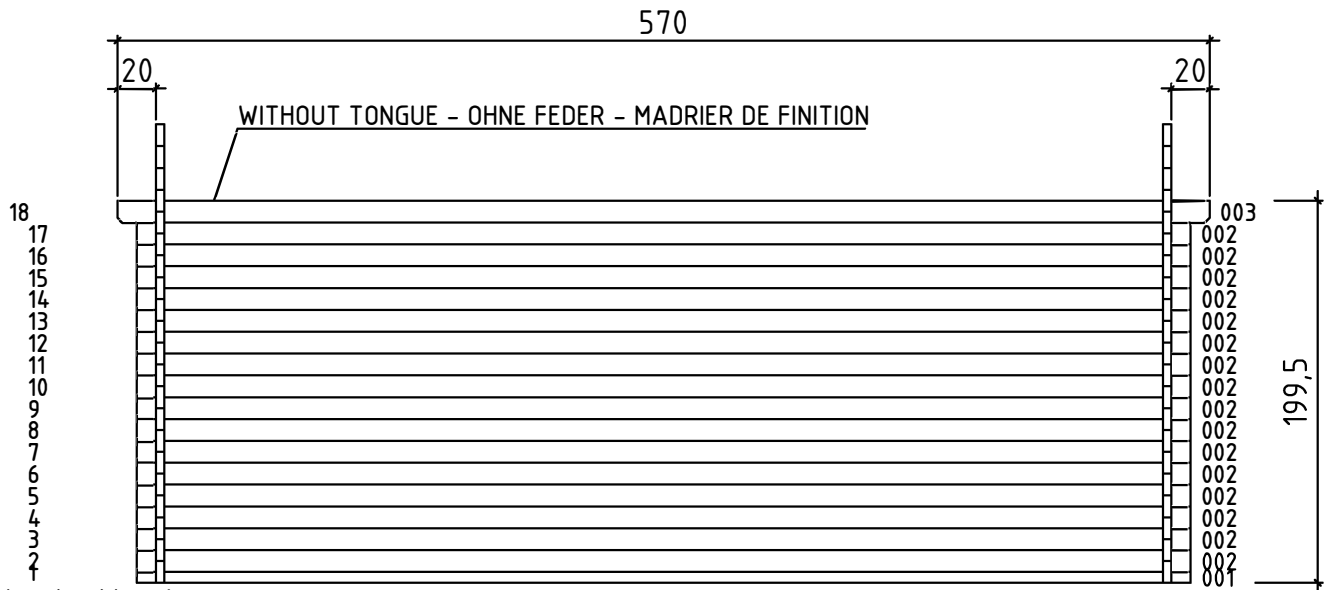

Wall - Wand - Mur 1

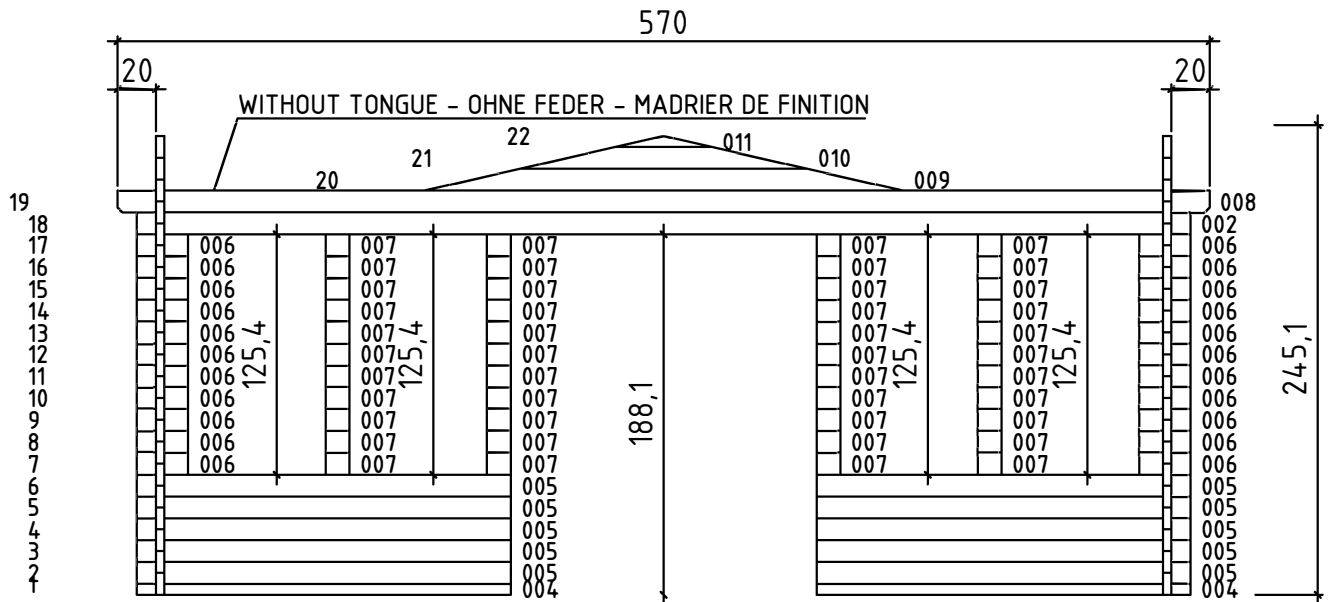
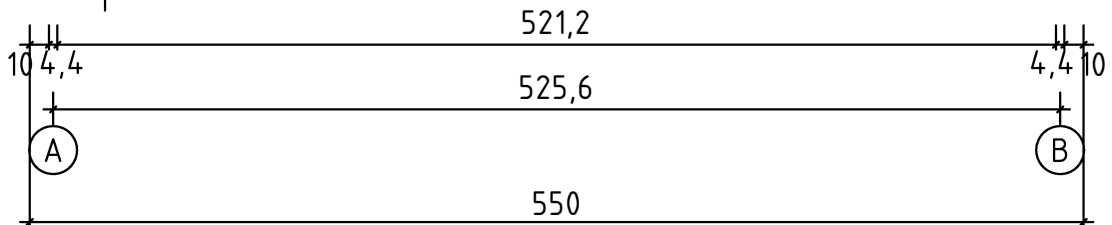

Wall - Wand - Mur 2

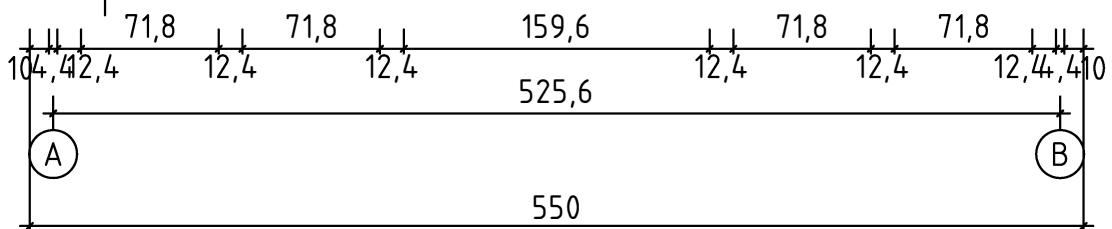

ROOFING FELT MUST BE APPLIED BEFORE APPLYING ROOF SHIELD ELEMENTS!

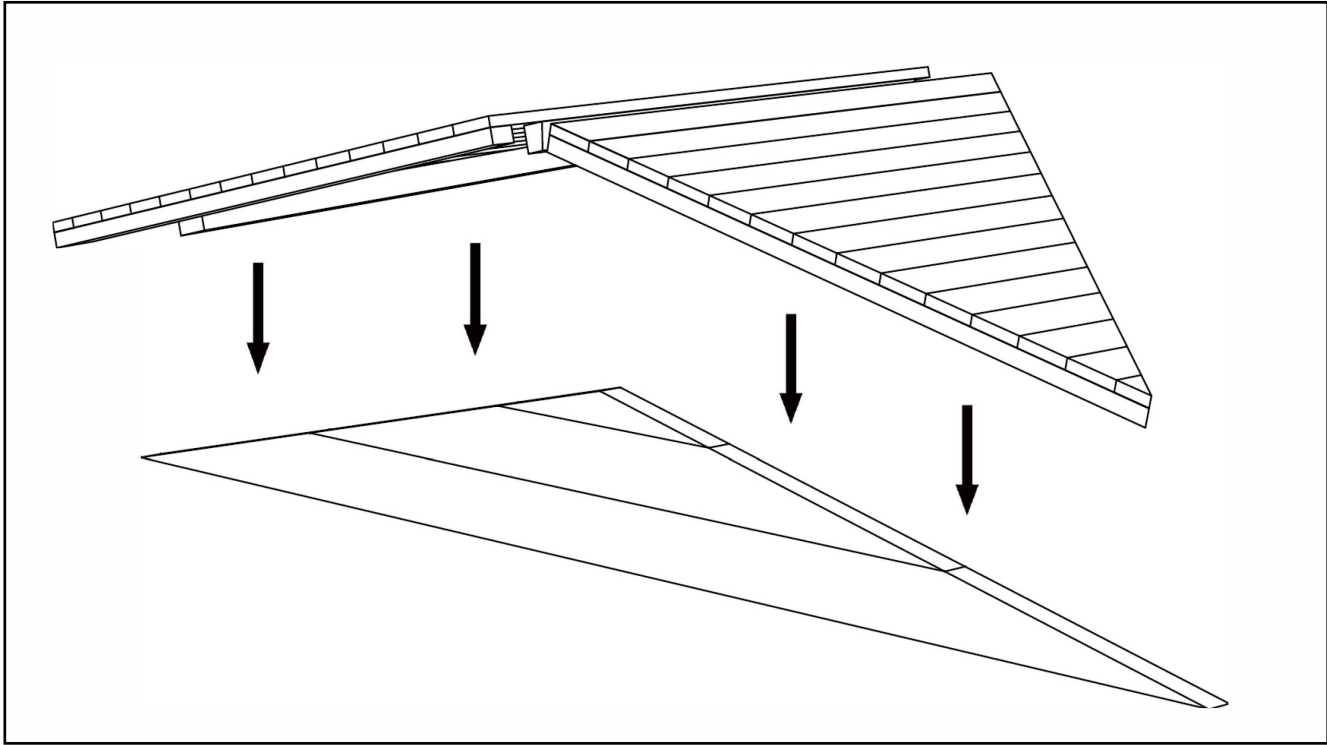
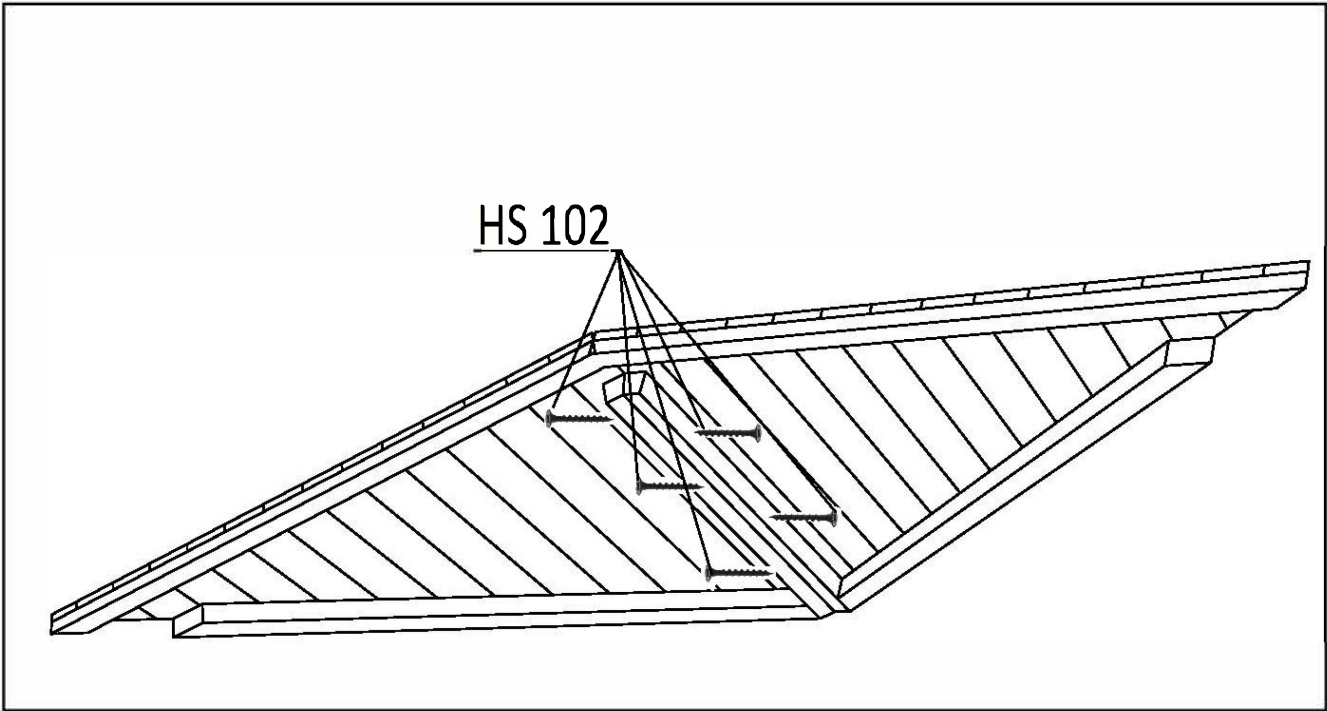



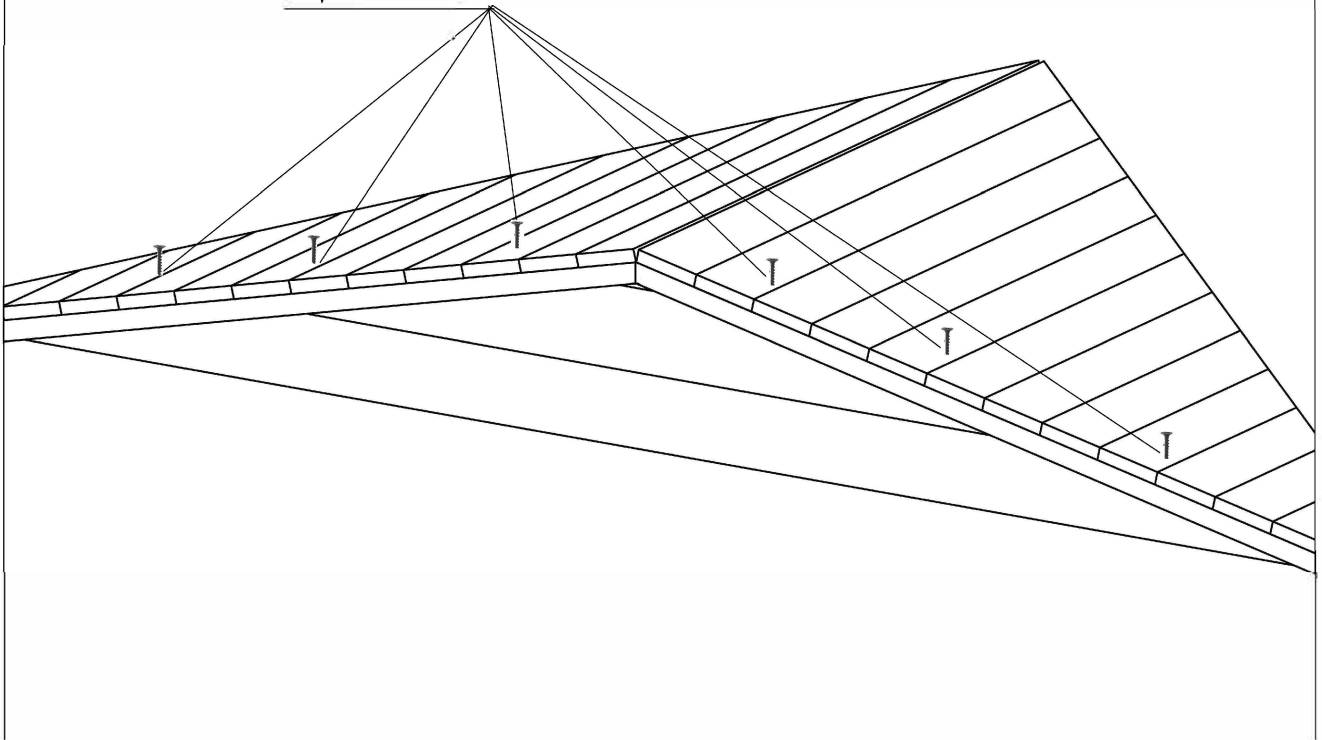



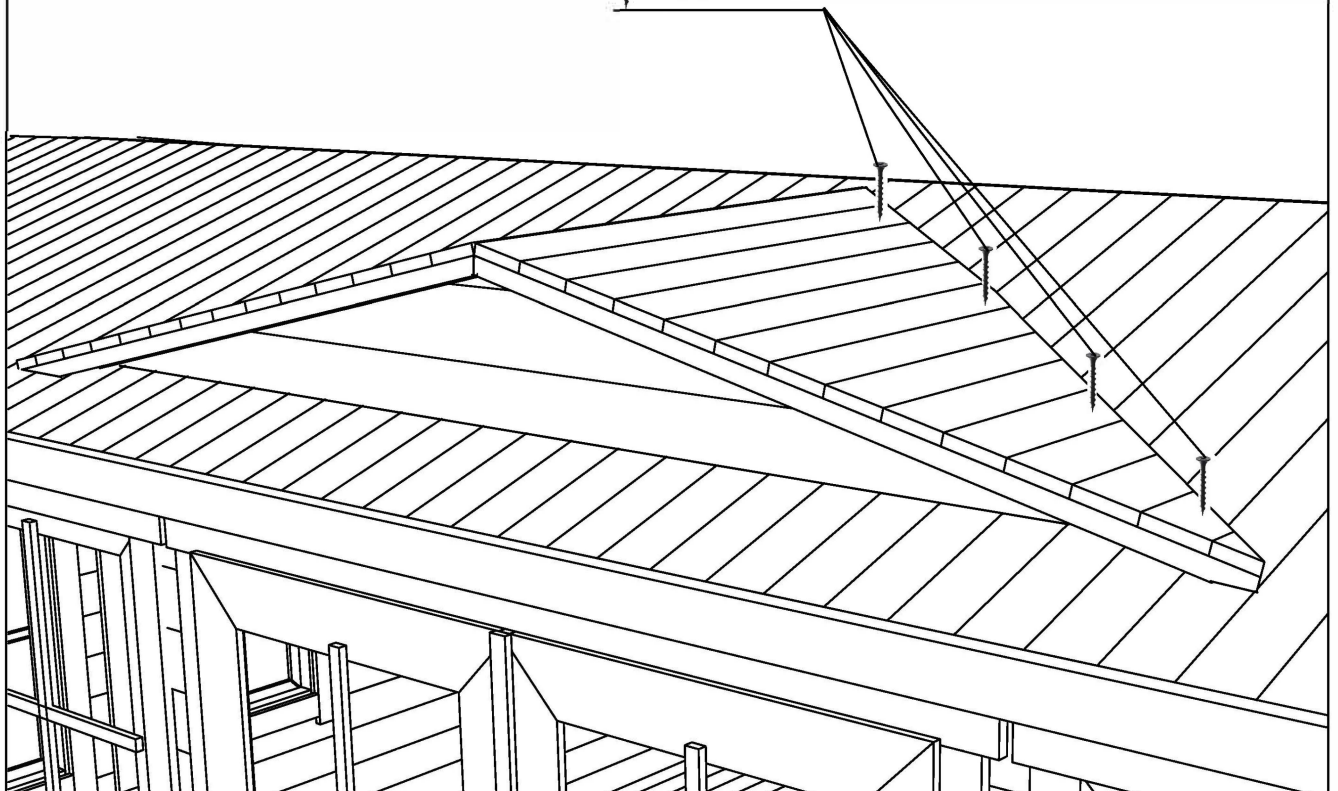

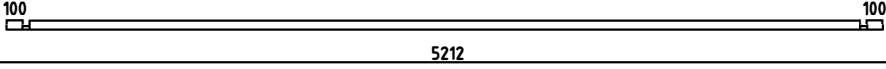
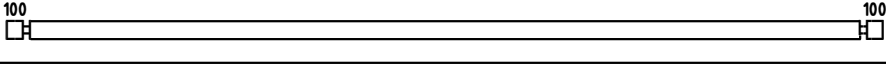
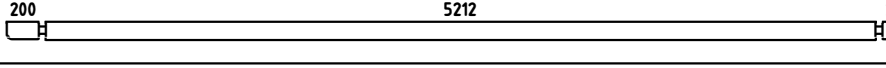
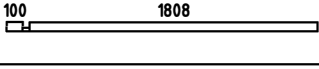
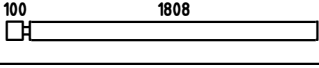

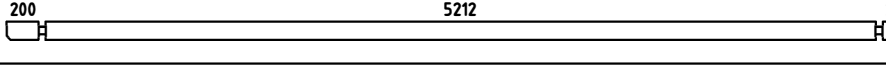
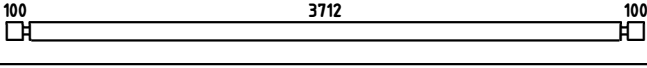
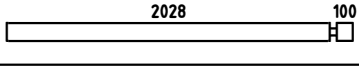

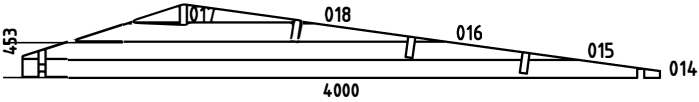
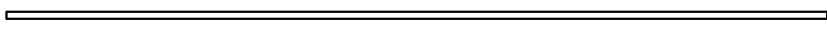
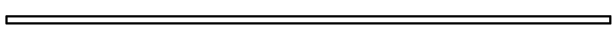
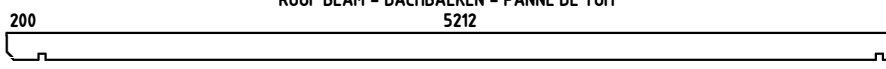
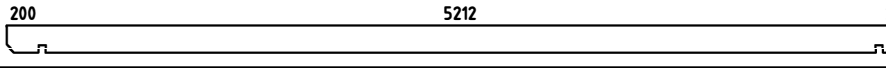
HS 102



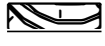





HS102



Pos	06.04.2016	Piece list - Stückliste - Liste des pièces	8/10	Q.	P (mm)	L (mm)
001				1	44x57	5500
002				17	44x114	5500
003				1	44x120	5700
004				2	44x57	1952
005				10	44x114	1952
006				33	44x114	268
007				55	44x114	124
008				1	44x120	5700
012				23	44x114	4000
013				11	44x114	2172
W2-1				1		
WA-1 WB-1				1 1		
IAR2				7	70x45	5150
IAR1				2	70x45	3790
PR1				1	44x170	5700
A-PR1				3	44x170	5700
		FLOOR BOARDS - FUSSBODENBRETTER - LAME DE PLANCHER		58	90x18	3708
		ROOF BOARDS - DACHBRETTER - VOLIGES		64	90x18	3100
		ROOF BOARDS - DACHBRETTER - VOLIGES		64	90x18	1200
		FLOOR FILLET - FUSSBODENLEISTE - CORNIERE DE FINITION DU PLANCHER			18x18	17.83
DPL-1		ROOFING FELT FILLET - DACHPAPPENLEISTE - BAGUETTE DE FIXATION DU FEUTRE BITUMEUX		2	18x58	1250
DPL-2		ROOFING FELT FILLET - DACHPAPPENLEISTE - BAGUETTE DE FIXATION DU FEUTRE BITUMEUX		2	18x58	1370
DPL-3		ROOFING FELT FILLET - DACHPAPPENLEISTE - BAGUETTE DE FIXATION DU FEUTRE BITUMEUX		2	18x58	3150
		FASCIA BOARD - TRAUFBRETT - BANDEAU DE TOIT		4	18x90	2850
DRV-4		ROOF EDGE REINFORCEMENT - DACHRANDVERSTÄRKUNG - CORNIERE DE RENFORT DE BORD DE TOIT		4	28x34	2850

Pos	06.04.2016	Piece list - Stückliste - Liste des pièces	9/10	Q.	P (mm)	L (mm)
KFS-1	STORM PROTECTION - STURMLEISTE - LATTE ANTI-TEMPETE			4	22x45	2050
GL-1	GABLE MOULDING - GIEBELLEISTE - PLANCHE DE RIVE			2	18x120	1250
GL-2	GABLE MOULDING - GIEBELLEISTE - PLANCHE DE RIVE			2	18x120	3150
GL-1	GABLE MOULDING - GIEBELLEISTE - PLANCHE DE RIVE			2	18x90	1370
	SCREW FOR GEORGIAN BARS - SCHRAUBE FÜR SPROSSEN - VIS DE BARRES GEORGIENNE			36	2.5x20	
	SCREW FOR GEORGIAN BARS - SCHRAUBE FÜR SPROSSEN - VIS DE BARRES GEORGIENNE			16	2.5x20	
	SCREW FOR GABLE SEGMENT - SCHRAUBEN FÜR DECKBLATT - VIS POUR FIXATION LOSANGE DE FINITION			6	3.5x35	
	SCREW FOR GABLE MOULDING - SCHRAUBEN FÜR GIEBELLEISTE - VIS DE FIXATION POUR PLANCHE DE RIVE			32	3.5x50	
	SCREW FOR DOOR FILLET - SCHRAUBE ZUR BEFESTIGUNG TÜRLEISTE - VIS D'ASSEMBLAGE DU CADRE DE PORTE			5	3x30	
HS102	SCREW FOR ROOF SHIELD - SCHRAUBE FÜR ELEMENT - VIS PUOR PANNEAU DE TOITURE			28	4x40	
	SCREW FOR FASCIA BOARDS - SCHRAUBEN FÜR TRAUFBRETT - VIS DE FIXATION POUR BANDEAU DE TOIT			34	4x40	
	SCREW FOR ROOF EDGE REINFORCEMENT - SCHRAUBEN FÜR DACHRANDVERSTÄRKUNG - VIS POUR RENFORT DE BORD DE TOIT			94	4x40	
HS101	SCREW FOR ROOF SHIELD - SCHRAUBE FÜR ELEMENT - VIS PUOR PANNEAU DE TOITURE			5	4x60	
	SCREW FOR ROOF BEAMS - SCHRAUBEN FÜR DACHBALKEN - VIS POUR PANNE DE TOIT			12	5x120	
	SCREW FOR 1. WALL BEAM - SCHRAUBE FÜR 1. BOHLENREIHE - VIS DE FIXATIONS 1ÈRE RANGÉE DE MADRIERS AVEC POUTRELLES DE FONDATIONS			8	5x90	
	SCREW FOR FOUNDATION - SCHRAUBEN ZUR BEFESTIGUNG FUNDAMENT - VIS DE FIXATIONS DES POUTRELLES DE FONDATIONS			14	5x90	
	SCREW FOR DOOR JAMB - SCHRAUBE FÜR TÜRRAHMEN - VIS DE FIXATION POUR MONTANT DE PORTE			4	5x90	
	WINDOW HANDLE FITTINGS - FENSTERGRIFF - POIGNÉE D'OUVERTURE DE FENETRE			6		
	ZN NAIL FOR FLOOR FILLET - ZN NÄGEL FÜR FUSSBODENLEISTE - POINTE POUR CORNIERE DE FINITION DU PLANCHER			36	1.4x40	
	HAMMER BLOCK - SCHLAGHOLZ - CALLE DE FRAPPE			1		
	SCREW FOR DOORSTEP - SCHRAUBEN FÜR TÜRSCHWELLE - VIS DE FIXATION DU SEUIL DE PORTE			3	4.5x65	
	ZN NAIL FOR ROOFING FELT FILLET - ZN NÄGEL FÜR DACHPAPPENLEISTE - POINTE POUR BAGUETTE FIXATION FEUTRE BITUMEUX			22	2x40	
	GABLE SEGMENT - DECKBLATT - LOSANGE DE FINITION			3		
	NUT FOR STORM PROTECTION - SCHRAUBENMUTTER FÜR STURMLEISTE - ÉCROU POUR LAME ANTI-TEMPETE			8		
	BOLT FOR STORM PROTECTION - BOLZEN FÜR STURMLEISTE - VIS POUR LAME ANTI-TEMPETE			8		

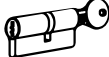
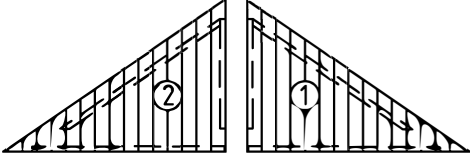
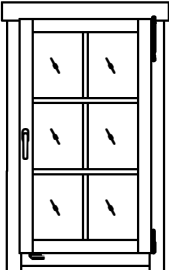
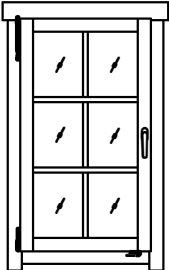
Pos	06.04.2016	Piece list - Stückliste - Liste des pièces	10/10	Q.	P (mm)	L (mm)
		WASHER FOR STORM PROTECTION - DICHTSCHEIBE FÜR STURMLEISTE - RONDELLE POUR LAME ANTI-TEMPETE		8		
		ZN NAIL FOR ROOF - ZN NÄGEL FÜR DACHBRETTER - POINTE POUR TOIT		398	2x50	
		ZN NAIL FOR FLOOR - ZN NÄGEL FÜR FUSSBODENBRETTER - CLOUS POUR PLANCHER		531	2x50	
		DOOR HANDLE FITTINGS-TÜRGRIF - SET DE GARNITURES DE SERRURE DE PORTE		1		
		SET OF DOOR LOCK COVERS - SCHLOSSBLENDEN - SET DE GARNITURES DE SERRURE DE PORTE		1		
		MALE BOLT HINGE FOR DOOR - TÜRRIEGEL - PARTIE MALE DE CHARNIERE DE PORTE		6		
		CYLINDER LOCK -ZYLINDERSCHLOSS - CYLINDRE DE SERRURE		1	30x35	
		ROOF SHIELD - ELEMENT - PANNEAU DE TOITURE		2		
		WINDOW - FESNTER - FENETRE 710x1224	AK.1.106.PSP	DGP+	2	
						
		WINDOW - FESNTER - FENETRE 710x1224	AK.1.106.PSV	DGP+	4	
						
		DOOR - TÜR - PORTE 1588x1850	TUK.1.108.PVP.MMa	DGP+	1	
		