

# Gustav E

1/6€



1.02.2018

Groundplan - Grundplan - Plan de masse - Planimetria -  
 Plattegrond - Põhiplaan

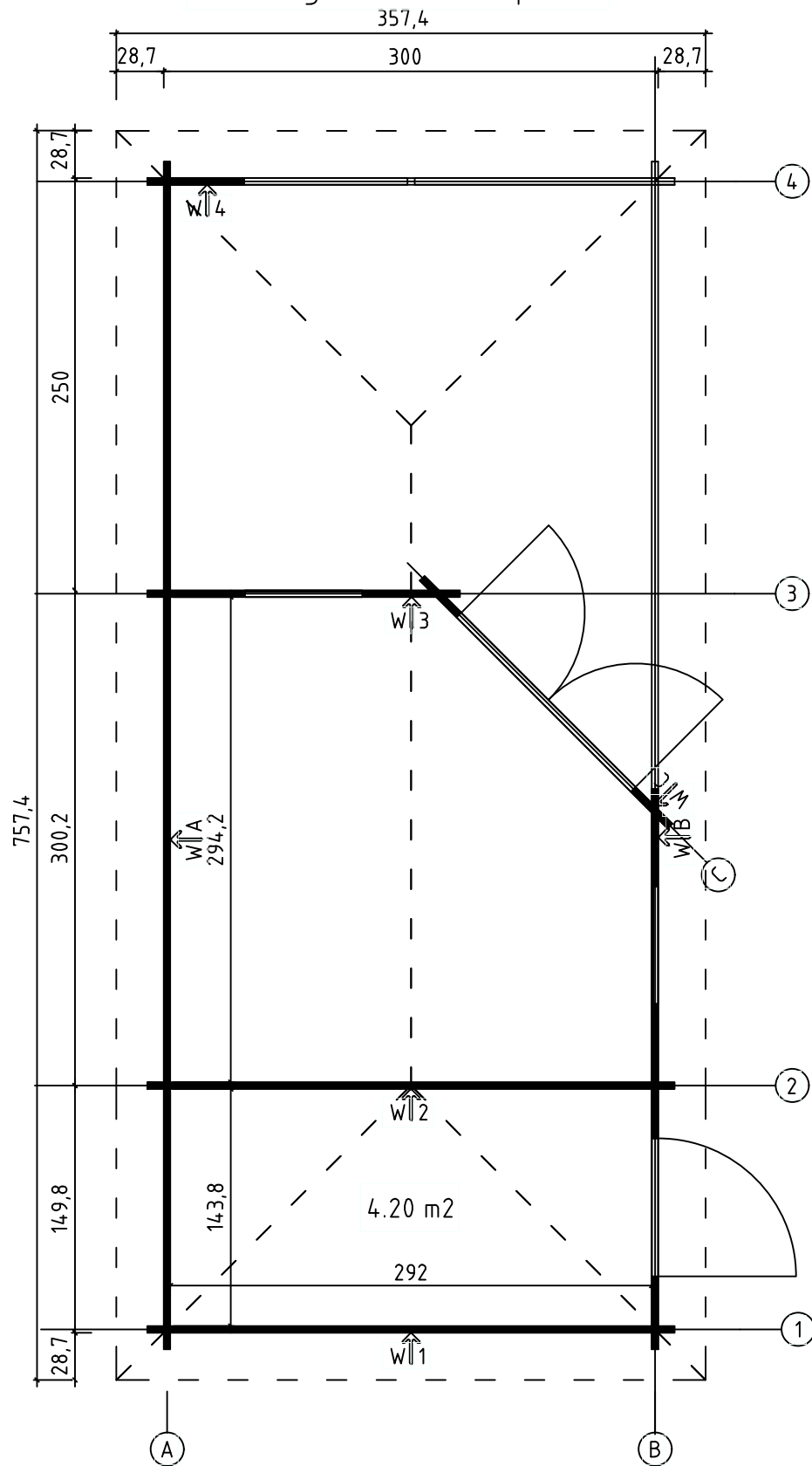

Foundation - Fundament - Fondation -  
 Fundamenta - Fundering - Immutatud alusraam

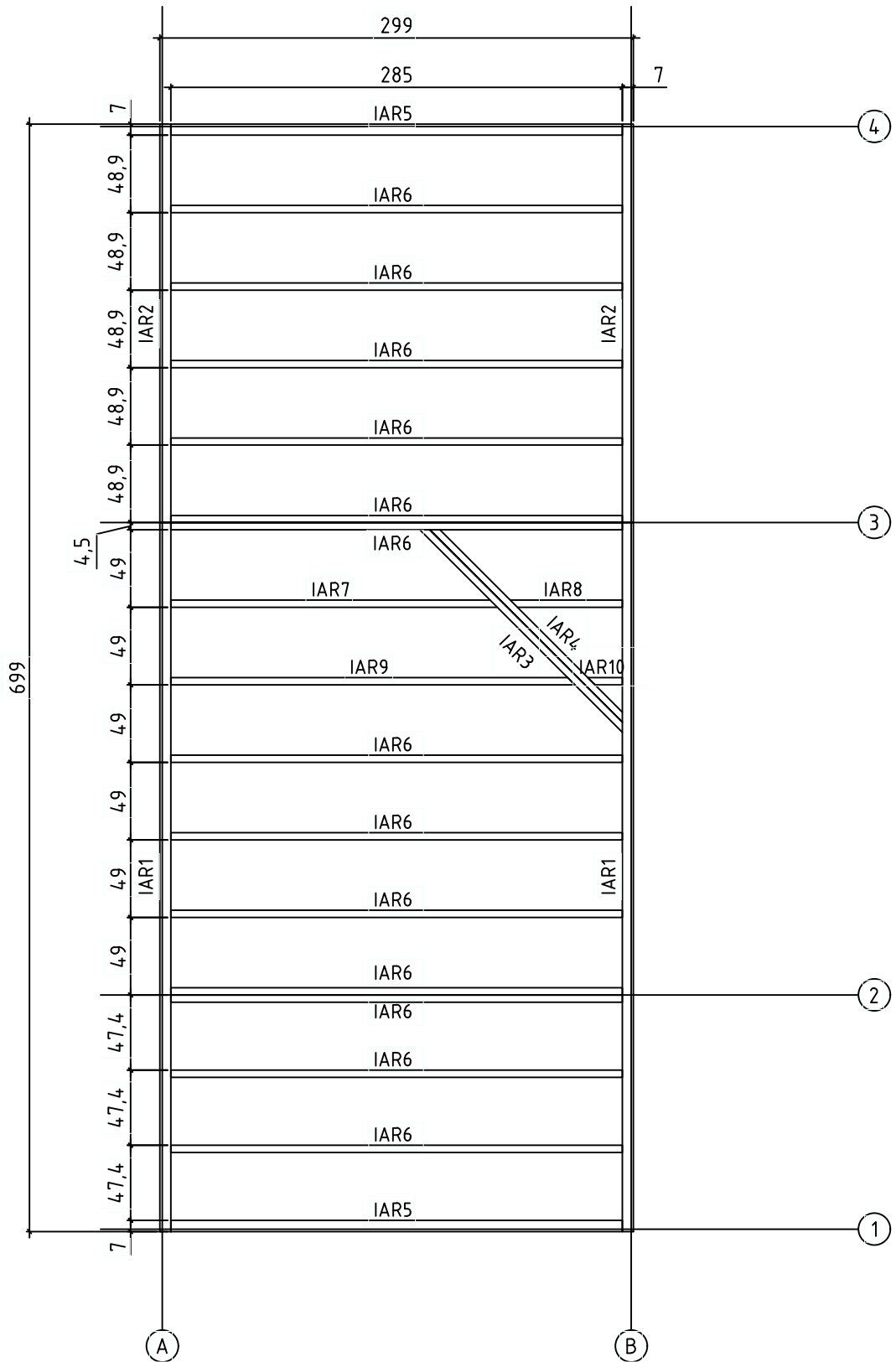

Terrace boards - Terrassenbretter - Plancher de terrasse -  
 Piattaforme terrazzo - Terrasvloer - Terrassilaudis

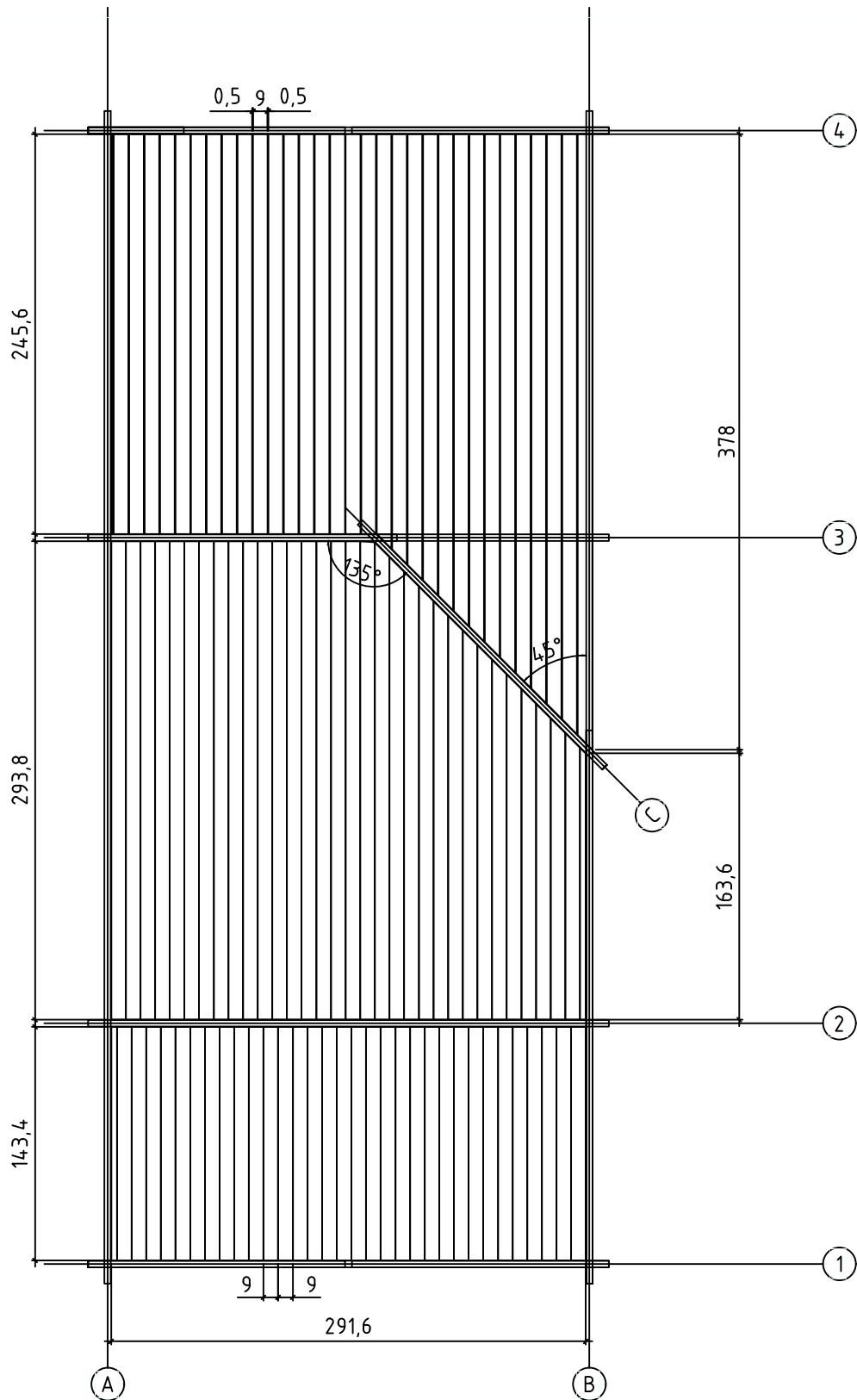

Floor boards - Fussbodenbretter - Plan pose plancher -  
 Pavimento - Vloerhout - Põrandalaudis

Overhead beams - Deckenbalken - Solives - Travi a vista -  
Overlopende balken - Laetalade konstruksioon

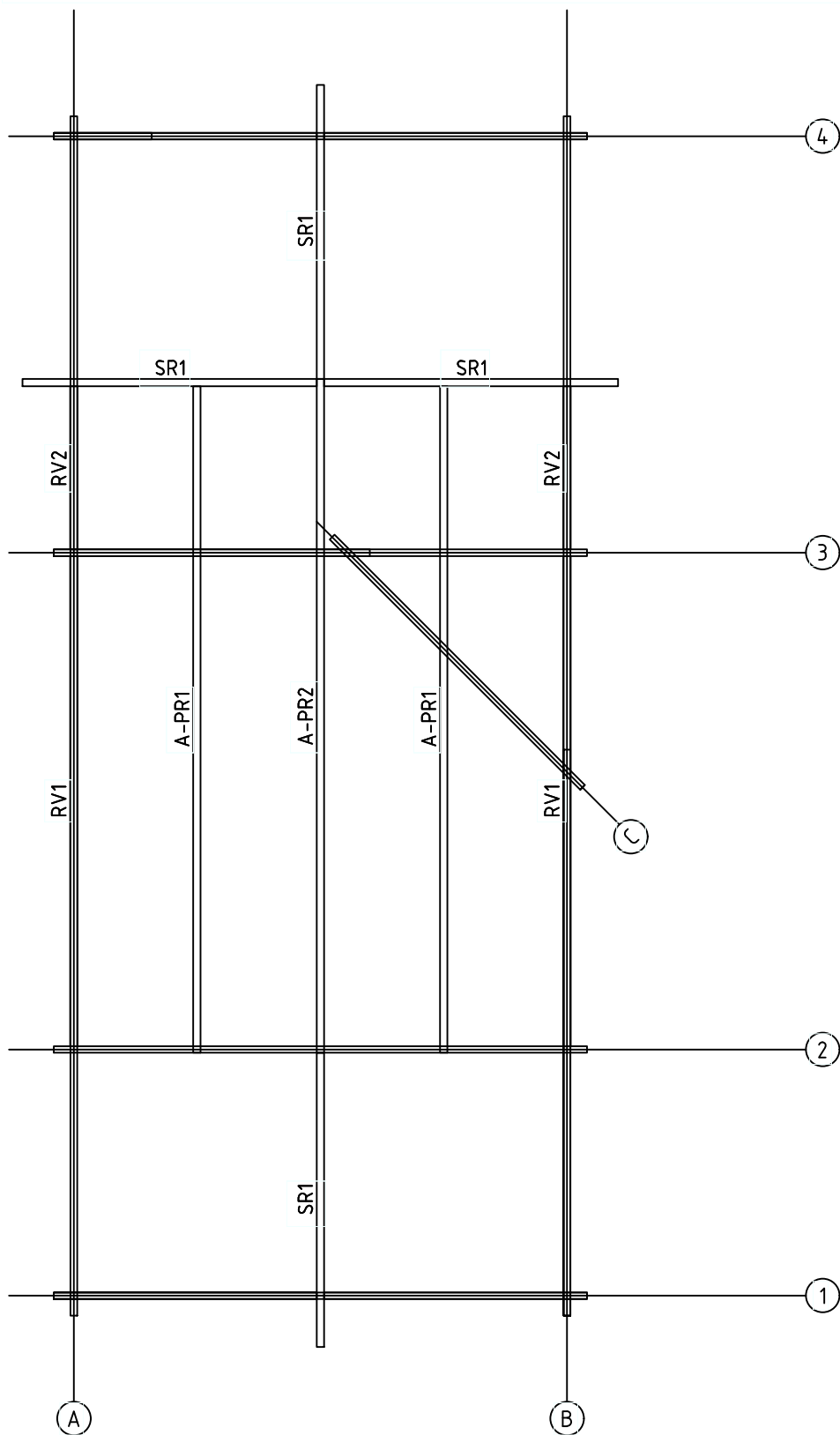

Diagonals must be equal - Prüfung diagonale Austrichtung -  
 Controle des diagonales - Le diagonali devono essere eguali -  
 Gelijkbenige diagonaal - Diagonaalid peavad olema võrdsed

$$A=B, C=D; E=F$$

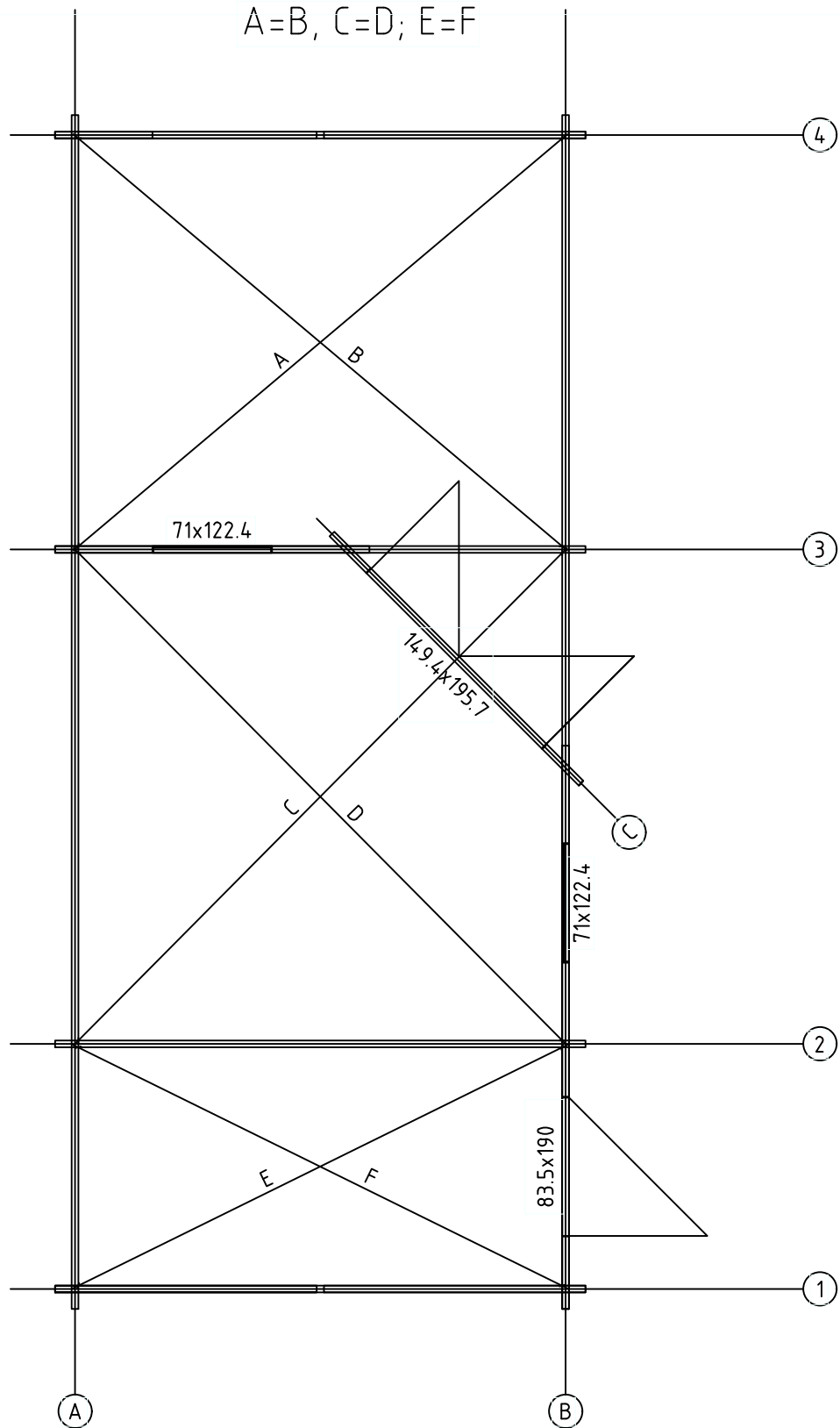

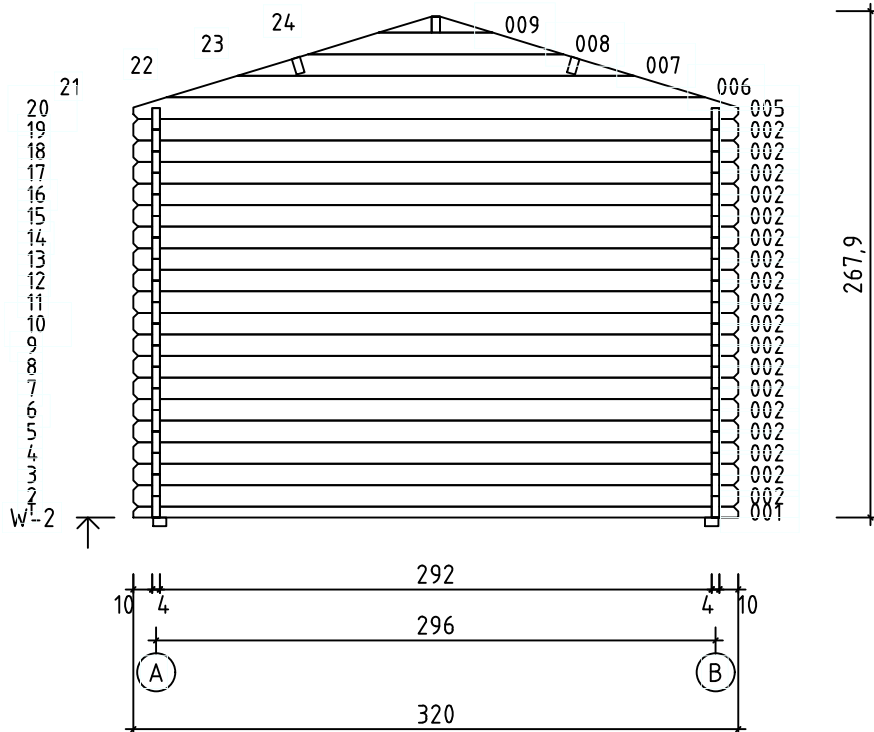
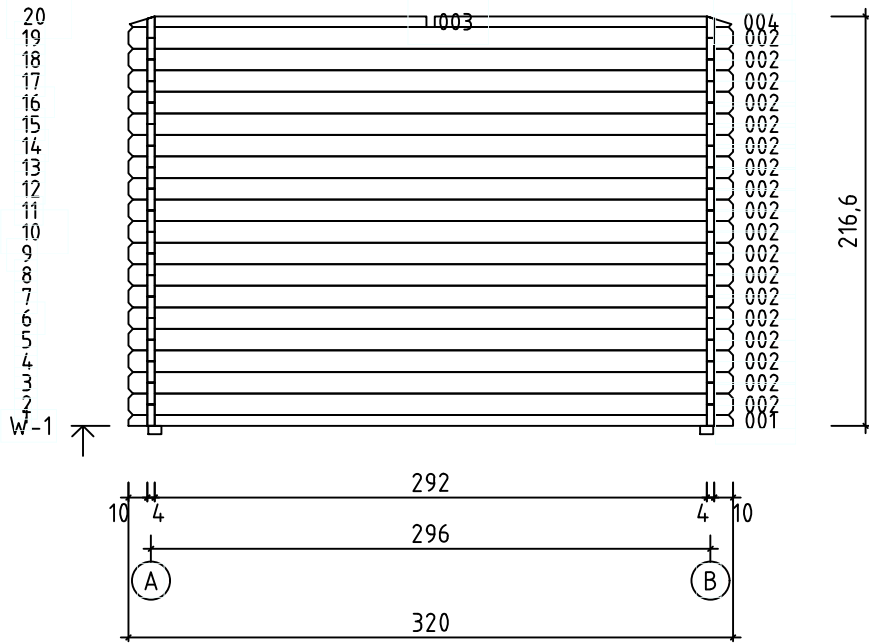

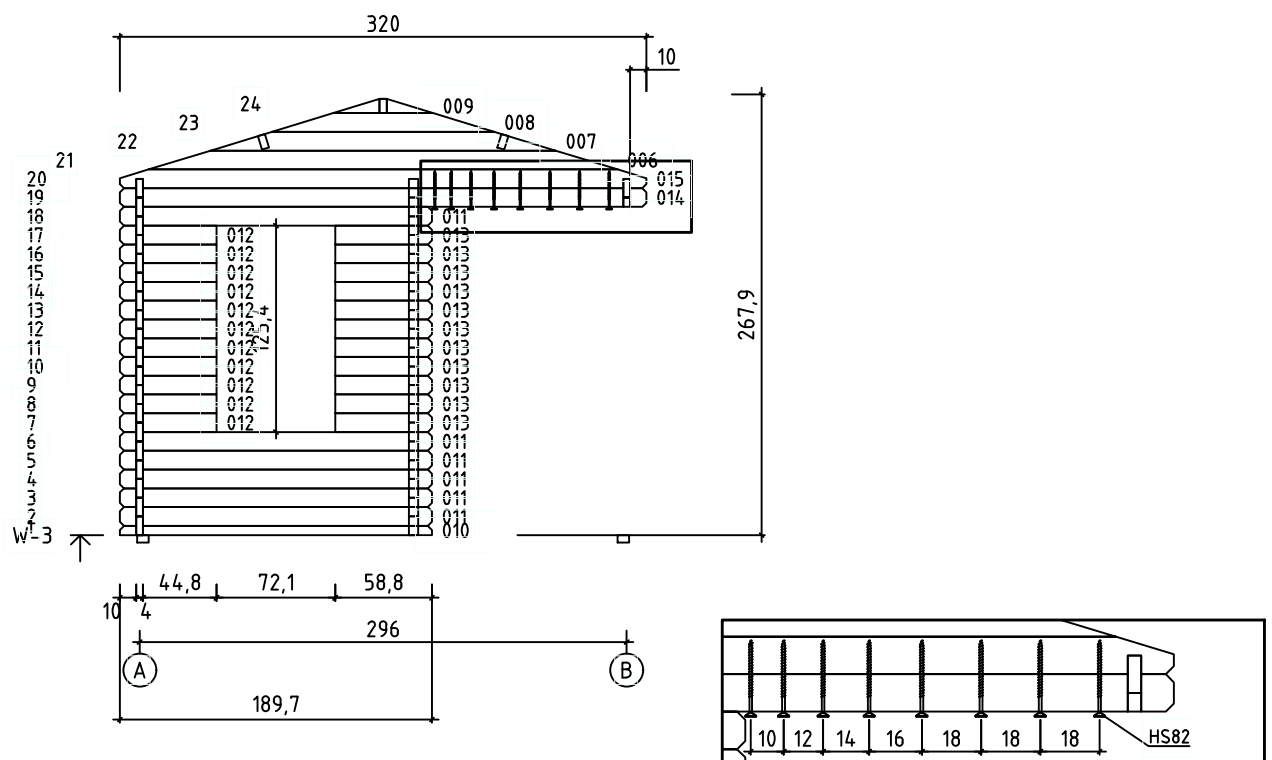

To prevent splits in the wood, pre-drilling screw holes ( $\phi 5$ ) is needed

Um der Rissbildung im Holz vorzubeugen, ist es notwendig die Schraubenlöcher mit einem Durchmesser von 5 mm vorzubohren.

Afin d'éviter le risque de fissuration du bois c'est obligatoire de percer auparavant les trous des vis de diamètres 5mm.

Per evitare di rompere il legno, prima di avvitare la vite autofilettante, preparare la sede con un foro ( $\phi 5$ ).

Om te voorkomen dat het hout splijt, is het nodig om de schroefgaten voor te boren ( $\phi 5$ )

Puidulõhede vältimiseks on vajalik kruviaukude ettepuurimine ( $\phi 5$ ).



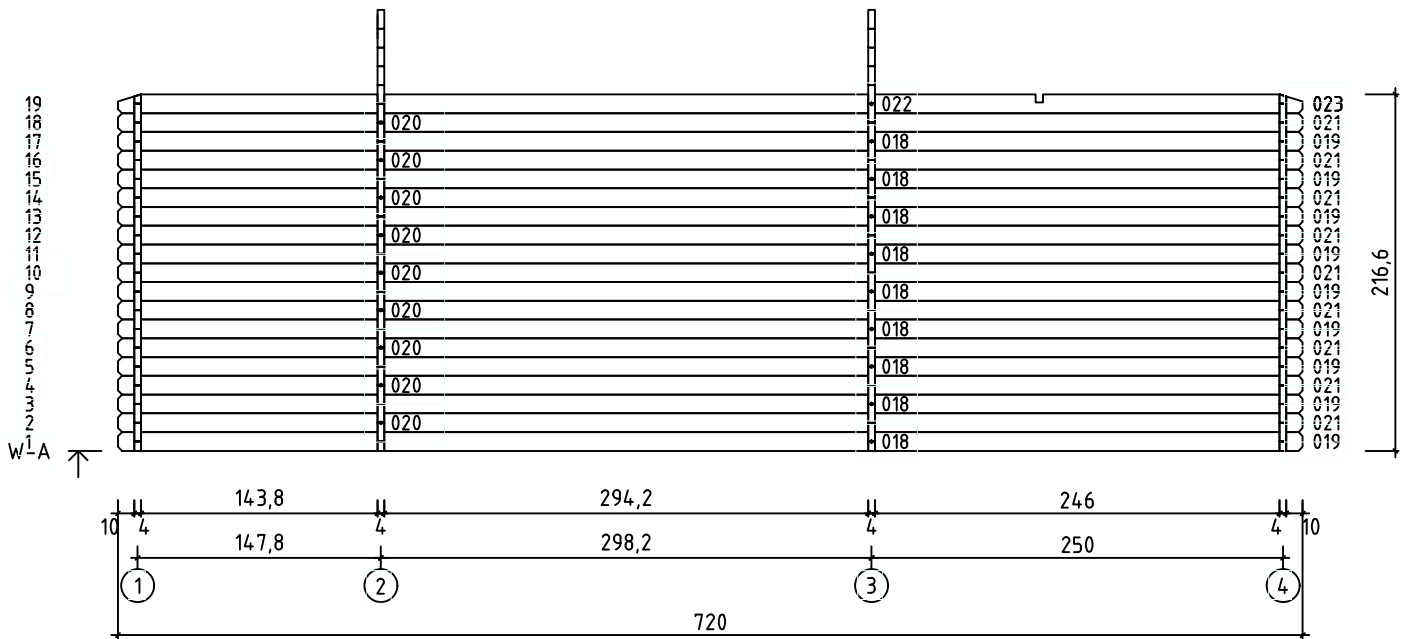
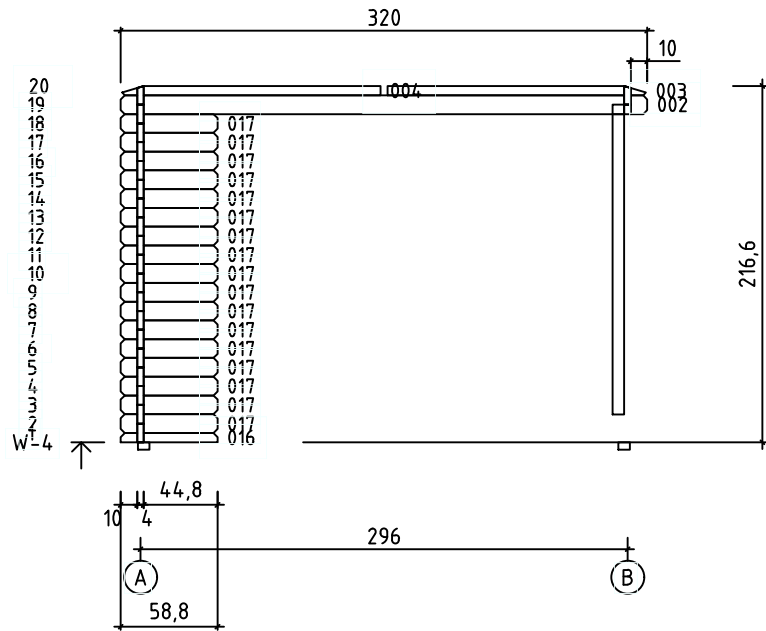



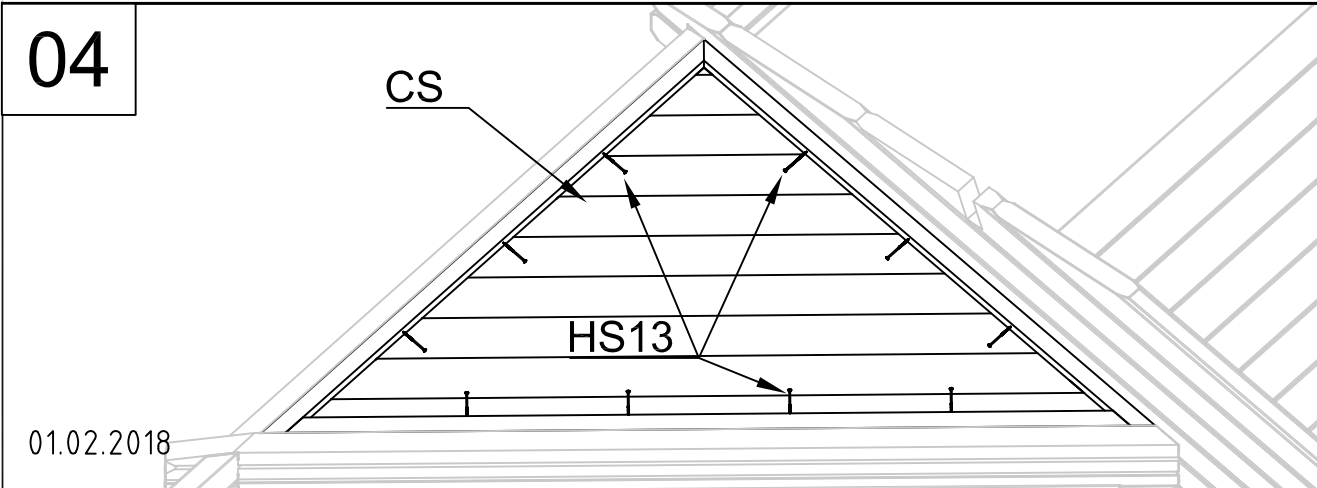
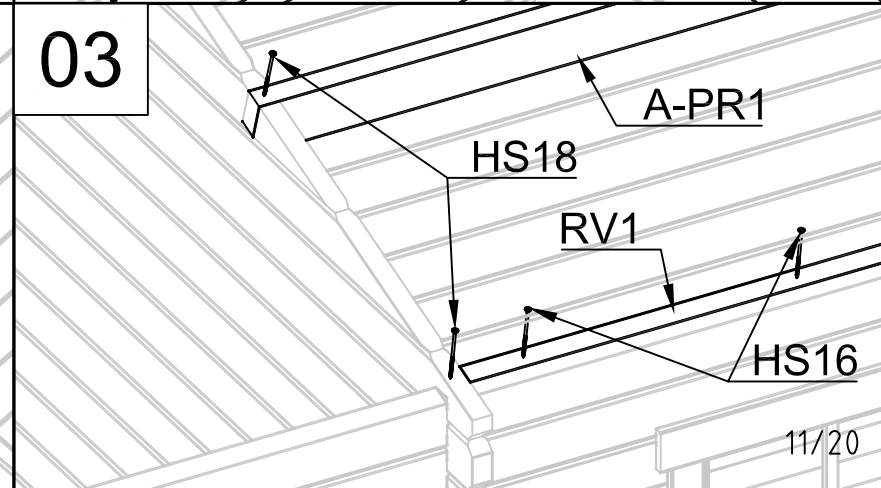
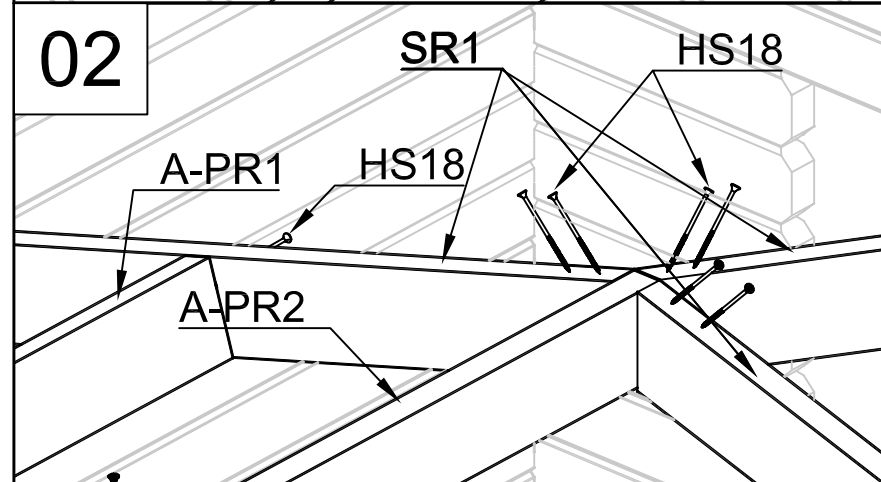
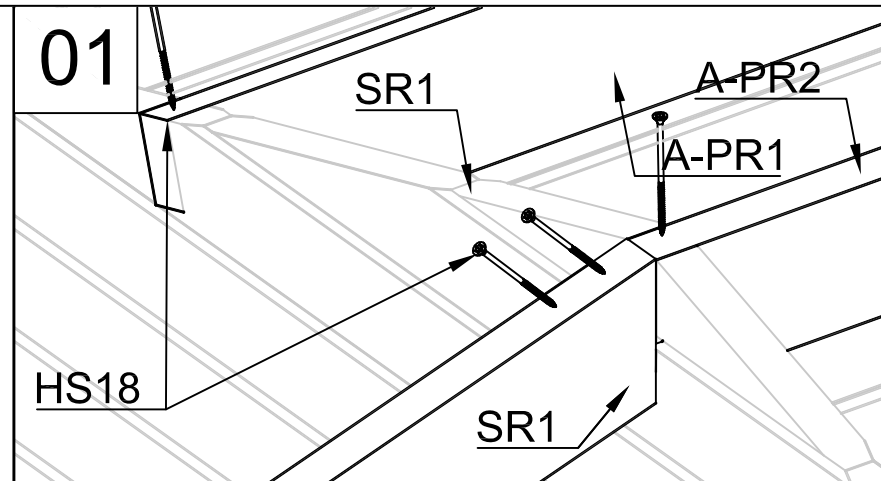
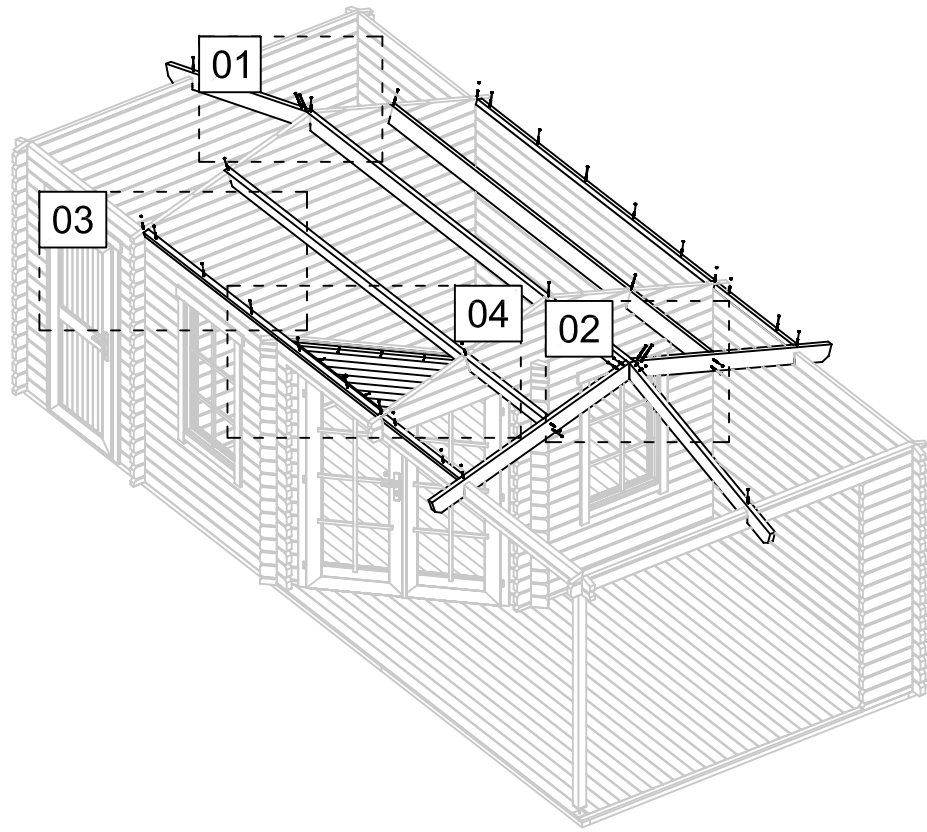

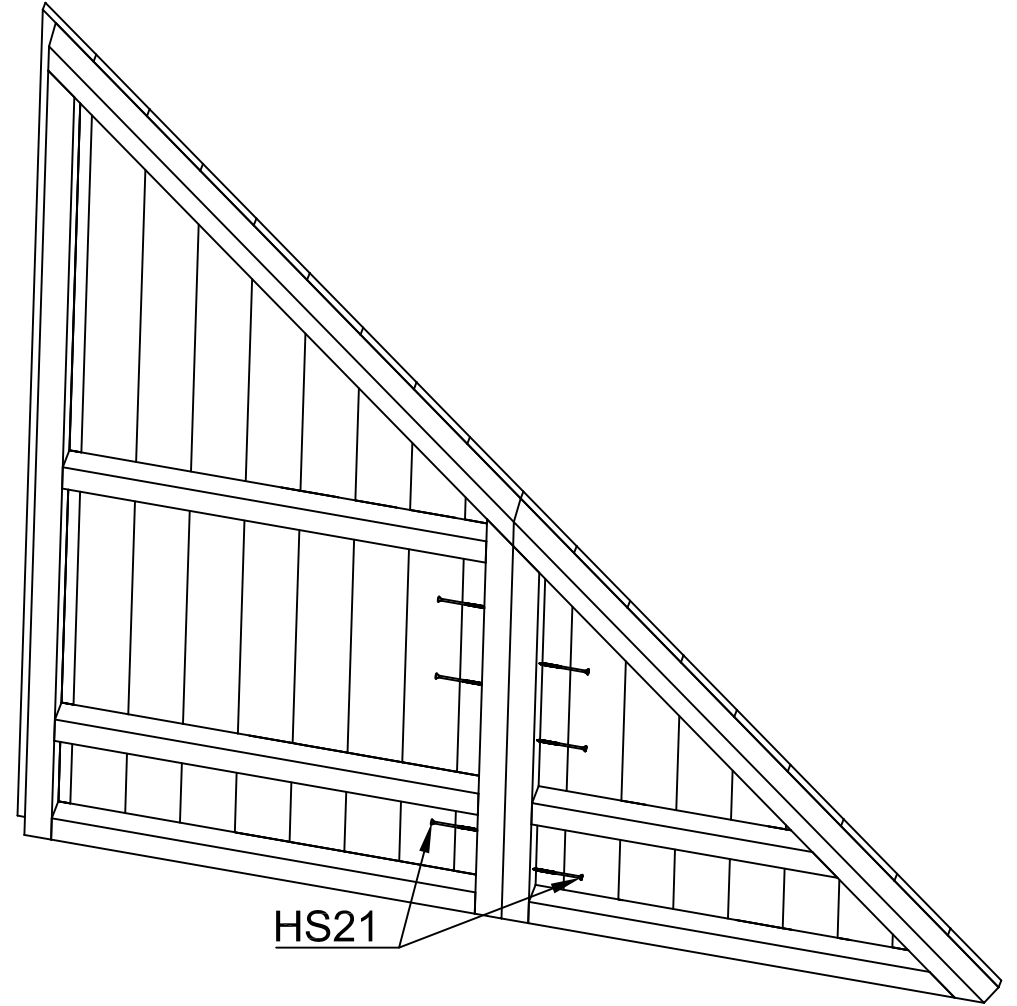
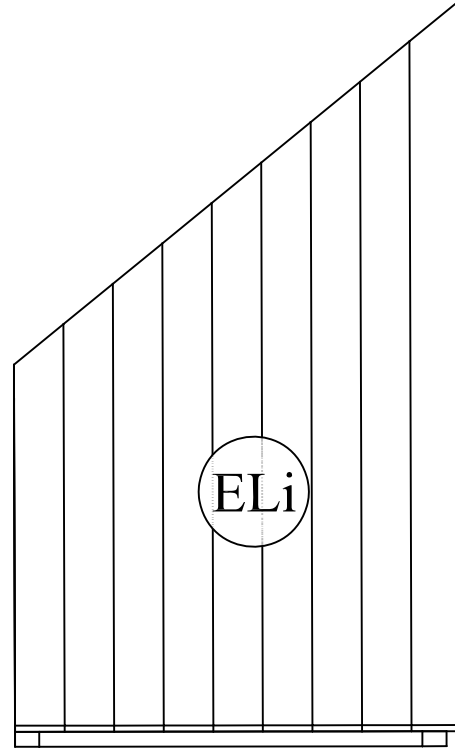
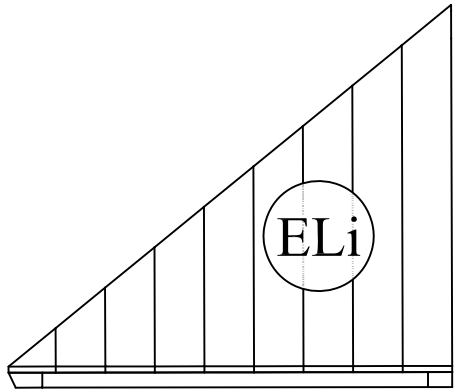

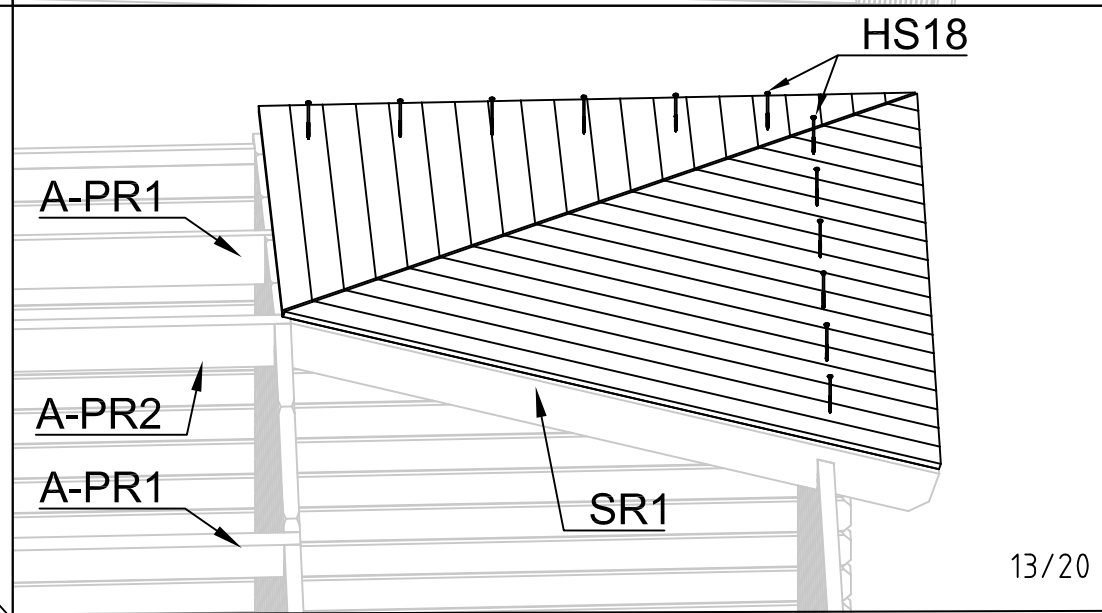
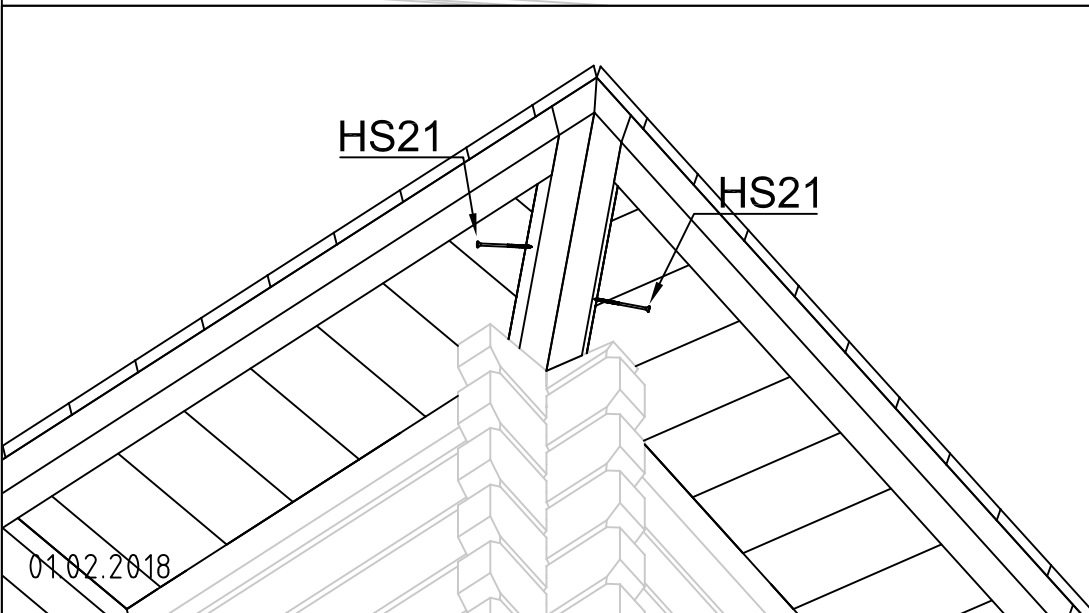
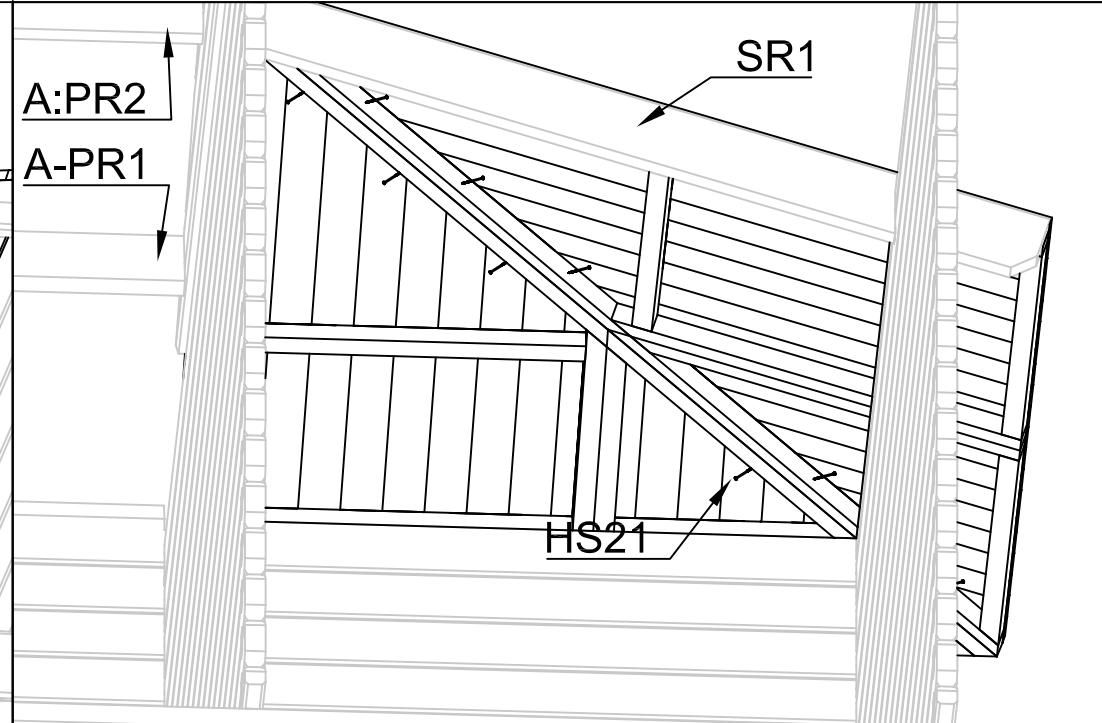
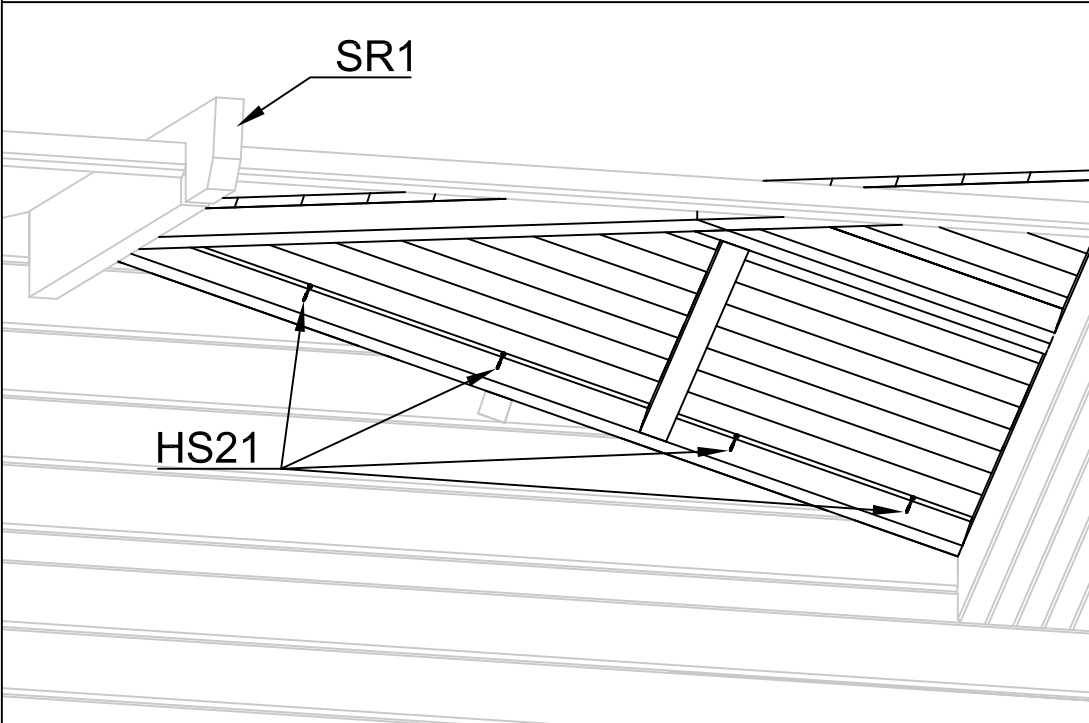

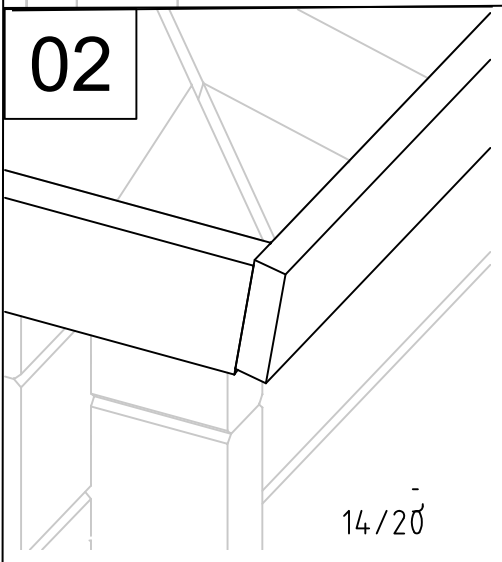
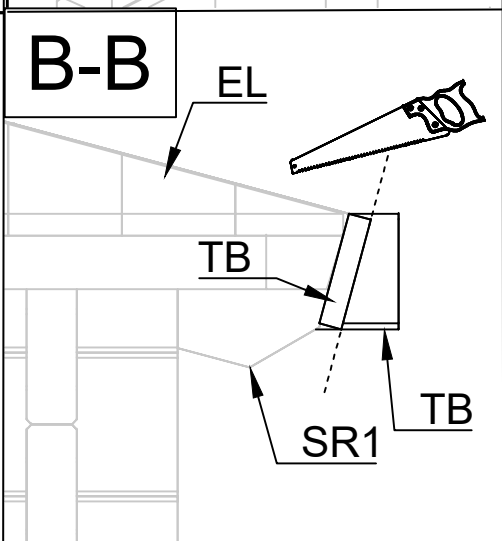
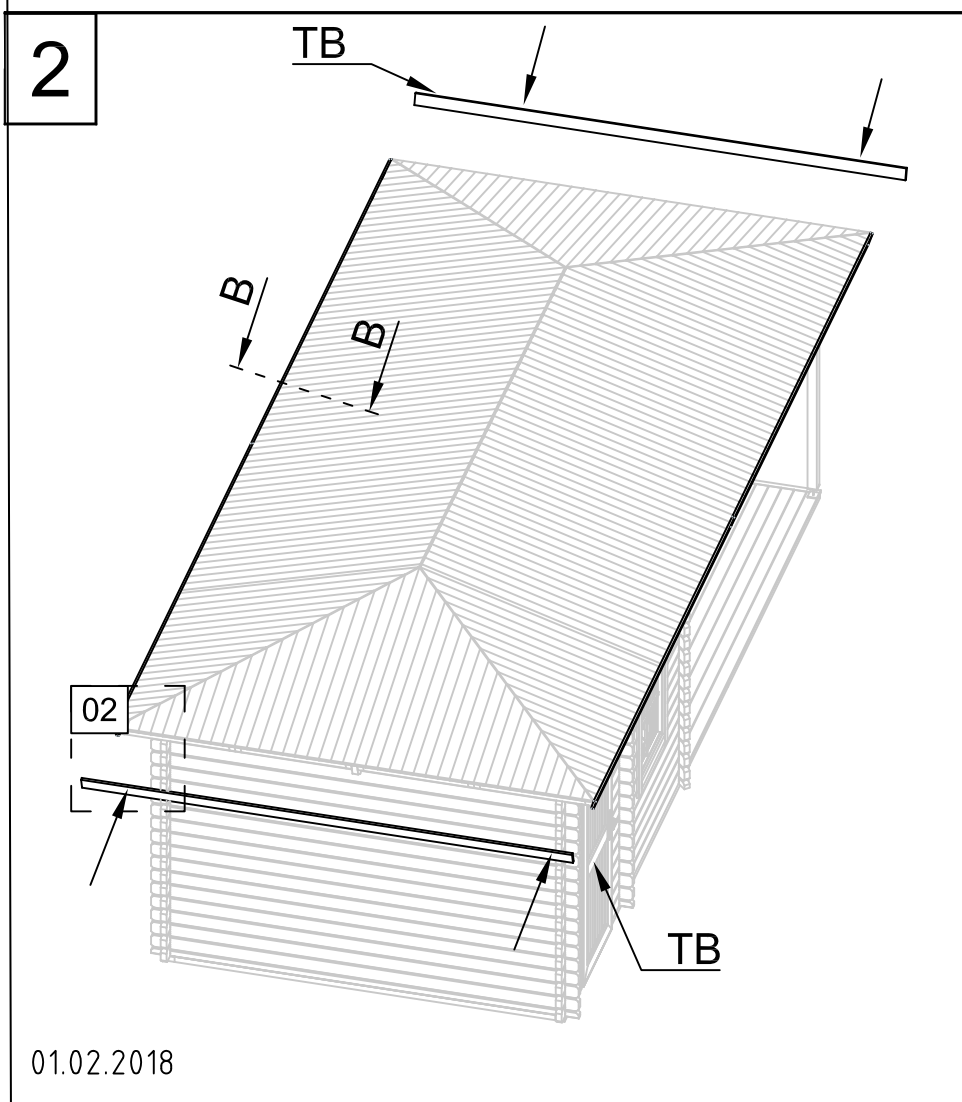
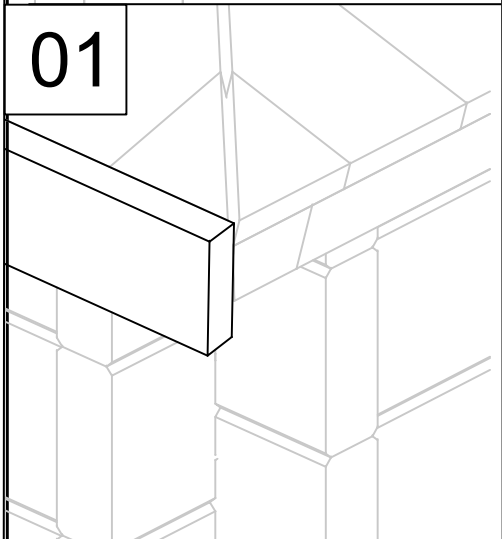
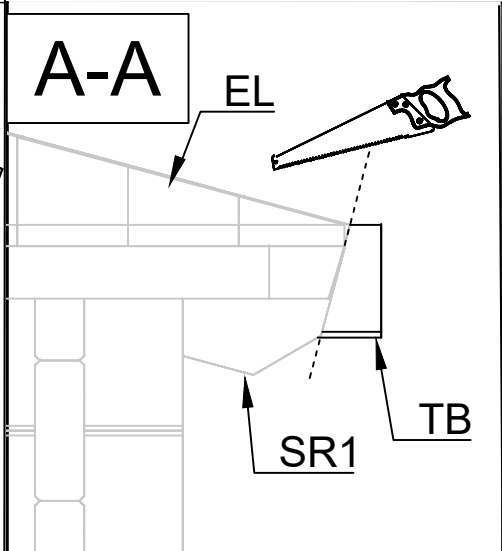
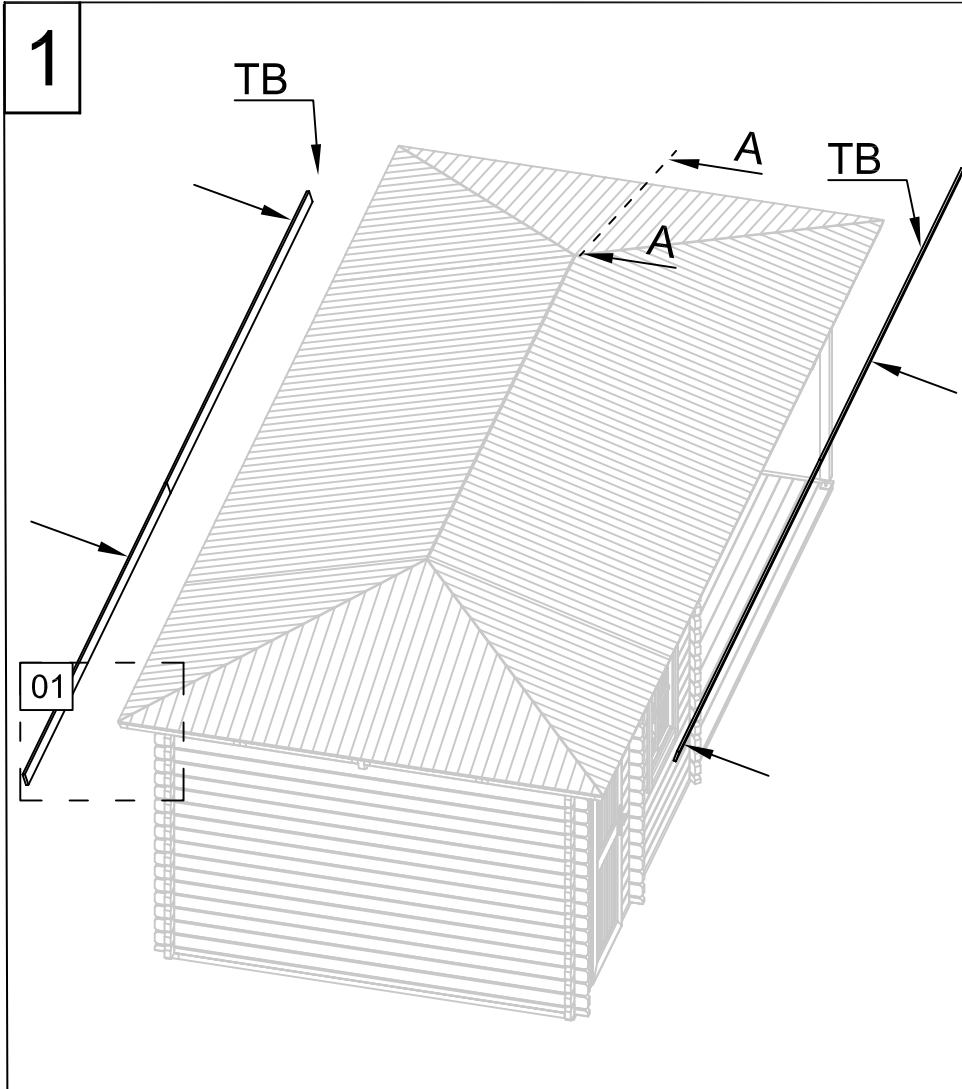

Piece list - Stückliste - Liste des pièces - Elementi - Stuklijst -  
 Tükítábel  
 Art.Nr. 4014610

15/20

Pos	Q	P (mm)	L (mm)
001	2	40x57	3200
002	37	40x114	3200
003	2	40x57	1570
004	2	40x57	1570
010	1	40x57	1897
011	6	40x114	1897
012	11	40x114	588
013	11	40x114	588
014	1	40x114	3200
016	1	40x57	588
017	17	40x114	588
018	9	40x114	4580
019	9	40x114	2620
020	10	40x114	1598
021	9	40x114	5602
022	1	40x114	4580
023	1	40x114	2620
024	17	40x114	436
025	6	40x114	2118
026	11	40x114	808
027	11	40x114	588
028	1	40x114	5602
029	1	40x114	4580

001

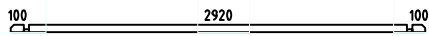

2

40x57

3200

002

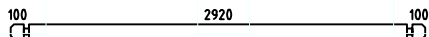

37

40x114

3200

003

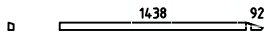

2

40x57

1570

004

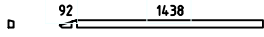

2

40x57

1570

010

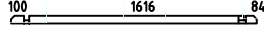

1

40x57

1897

011

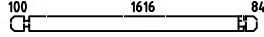

6

40x114

1897

012



11

40x114

588

013



11

40x114

588

014

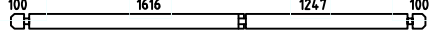

1

40x114

3200

016



1

40x57

588

017



17

40x114

588

018

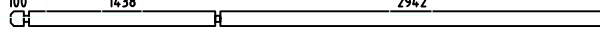

9

40x114

4580

019

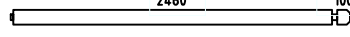

9

40x114

2620

020

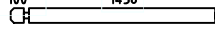

10

40x114

1598

021

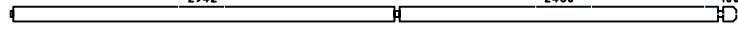

9

40x114

5602

022

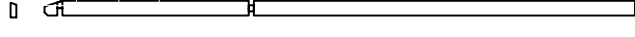

1

40x114

4580

023

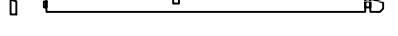

1

40x114

2620

024



17

40x114

436

025

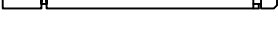

6

40x114

2118

026

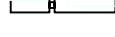

11

40x114

808

027



11

40x114

588

028

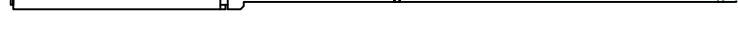

1

40x114

5602



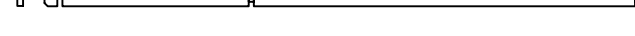





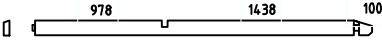

029



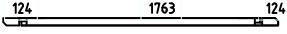
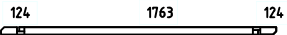
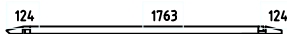
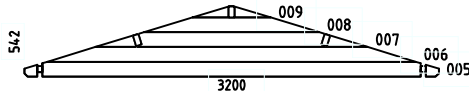
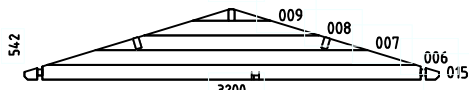
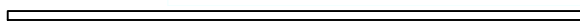
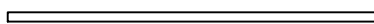
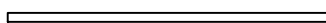
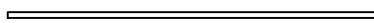
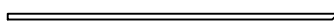

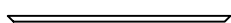

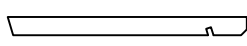





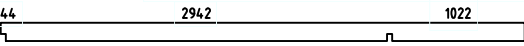
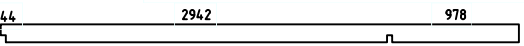

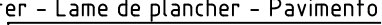

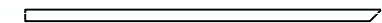

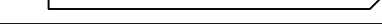

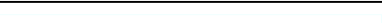
1



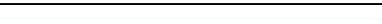
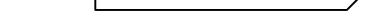



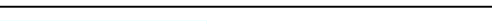



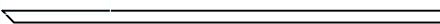

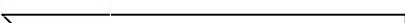
40x114

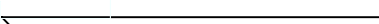



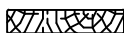

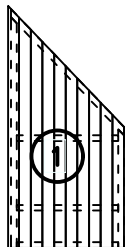
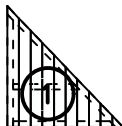
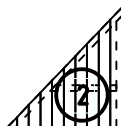
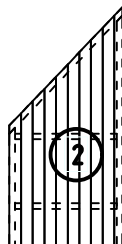
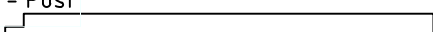

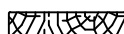

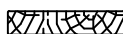

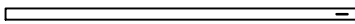
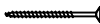

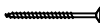
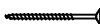
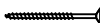
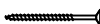



4580

Pos	01.02.2018	Piece list - Stückliste - Liste des pièces - Elementi - Stuklijst - Tükítabel Art.Nr. 4014610	16/20	Q	P (mm)	L (mm)
030				1	40x114	2620
031				1	40x57	310
032				17	40x114	310
033				17	40x114	310
034				1	40x57	310
035				1	40x57	2125
036				1	40x57	2125
037				1	40x57	2125
W2-1				1		
W3-1				1		
IAR1	 Foundation - Fundament - Fondation - Fondamenta - Fundering - Immutatud alusraam			2	70x45	4475
IAR5	 Foundation - Fundament - Fondation - Fondamenta - Fundering - Immutatud alusraam			2	70x45	2850
IAR2	 Foundation - Fundament - Fondation - Fondamenta - Fundering - Immutatud alusraam			2	70x45	2515
IAR6	 Foundation - Fundament - Fondation - Fondamenta - Fundering - Immutatud alusraam			13	45x45	2850
IAR9	 Foundation - Fundament - Fondation - Fondamenta - Fundering - Immutatud alusraam			1	45x45	2550
IAR7	 Foundation - Fundament - Fondation - Fondamenta - Fundering - Immutatud alusraam			1	45x45	2060
IAR3	 Foundation - Fundament - Fondation - Fondamenta - Fundering - Immutatud alusraam			1	45x45	1810
IAR4	 Foundation - Fundament - Fondation - Fondamenta - Fundering - Immutatud alusraam			1	45x45	1720
IAR8	 Foundation - Fundament - Fondation - Fondamenta - Fundering - Immutatud alusraam			1	45x45	707
IAR10	 Foundation - Fundament - Fondation - Fondamenta - Fundering - Immutatud alusraam			1	45x45	218
SR1	 SARIKAD			4	44x140	1845
RV1	 Lath - Pfetten - Liteau - Piccola asse - Gordingen - Roov			2	44x44	2942
RV2	 Lath - Pfetten - Liteau - Piccola asse - Gordingen - Roov			2	44x44	978







Pos	01.02.2018	Piece list - Stückliste - Liste des pièces - Elementi - Stuklijst - Tükítábel Art.Nr. 4014610	17/20	Q	P (mm)	L (mm)
A-PR2		Roof beam - Dachbalken - Panne de toit - Perlina del tetto - Gordingen / dakbalk - Pärlin 44  1022		1	44x140	4044
A-PR1		Roof beam - Dachbalken - Panne de toit - Perlina del tetto - Gordingen / dakbalk - Pärlin 44  978		2	44x140	4000
		Floor boards - Fussbodenbretter - Lame de plancher - Pavimento - Vloerhout - Põrandalaud 		18	90x18	2938
		Floor boards - Fussbodenbretter - Lame de plancher - Pavimento - Vloerhout - Põrandalaud 		1	90x18	2932
		Floor boards - Fussbodenbretter - Lame de plancher - Pavimento - Vloerhout - Põrandalaud 		1	90x18	2842
		Floor boards - Fussbodenbretter - Lame de plancher - Pavimento - Vloerhout - Põrandalaud 		1	90x18	2752
		Floor boards - Fussbodenbretter - Lame de plancher - Pavimento - Vloerhout - Põrandalaud 		1	90x18	2662
		Floor boards - Fussbodenbretter - Lame de plancher - Pavimento - Vloerhout - Põrandalaud 		1	90x18	2572
		Floor boards - Fussbodenbretter - Lame de plancher - Pavimento - Vloerhout - Põrandalaud 		1	90x18	2482
		Floor boards - Fussbodenbretter - Lame de plancher - Pavimento - Vloerhout - Põrandalaud 		1	90x18	2392
		Floor boards - Fussbodenbretter - Lame de plancher - Pavimento - Vloerhout - Põrandalaud 		1	90x18	2302
		Floor boards - Fussbodenbretter - Lame de plancher - Pavimento - Vloerhout - Põrandalaud 		1	90x18	2212
		Floor boards - Fussbodenbretter - Lame de plancher - Pavimento - Vloerhout - Põrandalaud 		1	90x18	2122
		Floor boards - Fussbodenbretter - Lame de plancher - Pavimento - Vloerhout - Põrandalaud 		1	90x18	2032
		Floor boards - Fussbodenbretter - Lame de plancher - Pavimento - Vloerhout - Põrandalaud 		1	90x18	1942
		Floor boards - Fussbodenbretter - Lame de plancher - Pavimento - Vloerhout - Põrandalaud 		1	90x18	1852
		Floor boards - Fussbodenbretter - Lame de plancher - Pavimento - Vloerhout - Põrandalaud 		1	90x18	1762
		Floor boards - Fussbodenbretter - Lame de plancher - Pavimento - Vloerhout - Põrandalaud 		1	90x18	1672
		Floor boards - Fussbodenbretter - Lame de plancher - Pavimento - Vloerhout - Põrandalaud 		33	90x18	1434
		Terrace boards - Terrassenbretter - Plancher de terrasse - Piattaforme terrazzo - Terrasvloer - Terrassilaud 		1	90x19	3780
		Terrace boards - Terrassenbretter - Plancher de terrasse - Piattaforme terrazzo - Terrasvloer - Terrassilaud 		1	90x19	3685
		Terrace boards - Terrassenbretter - Plancher de terrasse - Piattaforme terrazzo - Terrasvloer - Terrassilaud 		1	90x19	3590
		Terrace boards - Terrassenbretter - Plancher de terrasse - Piattaforme terrazzo - Terrasvloer - Terrassilaud 		1	90x19	3495

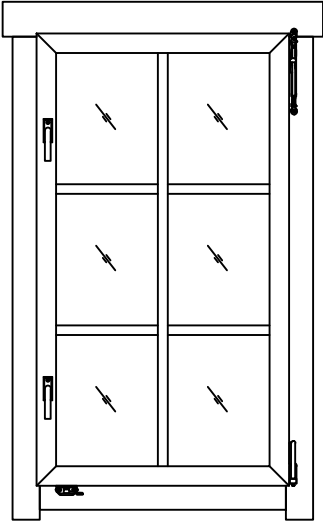
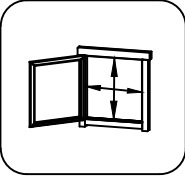

Pos	Piece list - Stückliste - Liste des pièces - Elementi - Stuklijst - Tükítábel Art. Nr. 4014610	18/20	Q	P (mm)	L (mm)
	Terrace boards - Terrassenbretter - Plancher de terrasse - Piattaforme terrazzo - Terrasvloer - Terrassilaud 		1	90x19	3400
	Terrace boards - Terrassenbretter - Plancher de terrasse - Piattaforme terrazzo - Terrasvloer - Terrassilaud 		1	90x19	3305
	Terrace boards - Terrassenbretter - Plancher de terrasse - Piattaforme terrazzo - Terrasvloer - Terrassilaud 		1	90x19	3210
	Terrace boards - Terrassenbretter - Plancher de terrasse - Piattaforme terrazzo - Terrasvloer - Terrassilaud 		1	90x19	3115
	Terrace boards - Terrassenbretter - Plancher de terrasse - Piattaforme terrazzo - Terrasvloer - Terrassilaud 		1	90x19	3020
	Terrace boards - Terrassenbretter - Plancher de terrasse - Piattaforme terrazzo - Terrasvloer - Terrassilaud 		1	90x19	2925
	Terrace boards - Terrassenbretter - Plancher de terrasse - Piattaforme terrazzo - Terrasvloer - Terrassilaud 		1	90x19	2830
	Terrace boards - Terrassenbretter - Plancher de terrasse - Piattaforme terrazzo - Terrasvloer - Terrassilaud 		1	90x19	2735
	Terrace boards - Terrassenbretter - Plancher de terrasse - Piattaforme terrazzo - Terrasvloer - Terrassilaud 		1	90x19	2640
	Terrace boards - Terrassenbretter - Plancher de terrasse - Piattaforme terrazzo - Terrasvloer - Terrassilaud 		1	90x19	2545
	Terrace boards - Terrassenbretter - Plancher de terrasse - Piattaforme terrazzo - Terrasvloer - Terrassilaud 		18	90x19	2456
	Roof boards - Dachbretter - Voliges - Perlina per tetto - Dakhout - Katuselaud 		90	90x18	1868
CS	Ceiling shield - Element - Panneau de toiture - Pannelo del soffitto - Plafond bedeking - Laekilp 		1		
EL	Roof element - Dachelement - Panneau de toit prémonté - Componente del tetto - Dakelement - Katusekilp  		4		
EL	Roof element - Dachelement - Panneau de toit prémonté - Componente del tetto - Dakelement - Katusekilp  		4		
	Post - Pfosten - Poteau - Piede registrabile - Stijl - Post 		1	70x70	1883
	Floor fillet - Fussbodenteiste - Corniere de finition du plancher - Finitura per pavimento (battisco pa) - Vloerafwerklijs - Põrandaliist 			18x18	19.65
TB-1	Fascia board - Traufbrett - Bandeau de toit - Finitura lati tetto - Gevellijst - Räästalaud 		2	18x90	3674

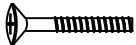
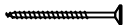

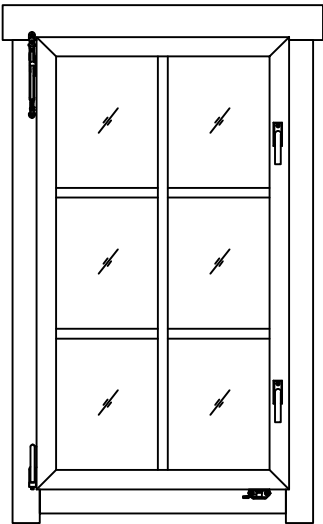
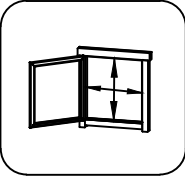

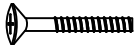
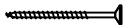

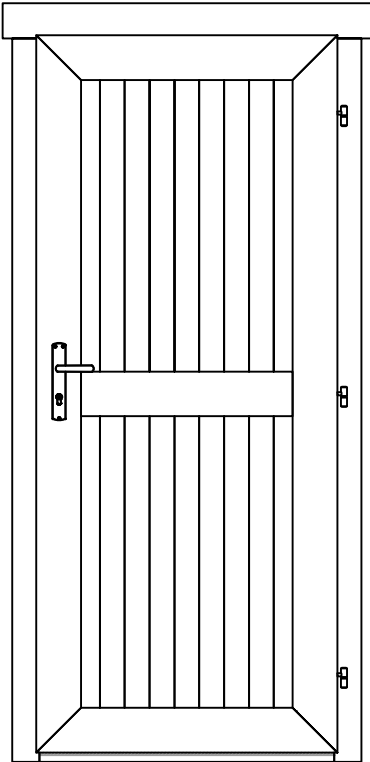
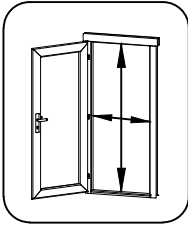
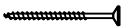
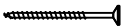
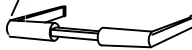
Pos	01.02.2018	Piece list - Stückliste - Liste des pièces - Elementi - Stuklijst - Tükítábel Art.Nr. 4.014.610	19/20	Q	P (mm)	L (mm)
TB-2	Fascia board - Traufbrett - Bandeau de toit - Finitura lati tetto - Gevellijst - Räästalaud		4	18x90	3840	
DRV-1	Roof edge reinforcement - Dachrandverstärkung - Corniere de renfort de bord de toit - Rinforzo x tetto - Dakrand versterking - Räästafugevdus		2	44x44	4000	
	Terrace edge board - Terrassenbrett, eingang - Lame de seuil d'entree de terrasse - Terrazzo uso abitacolo - Terrasyvloer dorpel - Terrassi servaliist		1	19x40	2510	
KFS-1	Storm protection - Sturmleiste - Latte anti-tempete - Protezione anti vento - Stormverankering / beveliging - Tormikinnitustiist		6	22x45	2500	
HS12	Screw for fascia boards - Schrauben für traufbretter - Vis pour fixation bandeau de toit - Viti x striscia del tetto - Schroef voor gevellijst - Kruvi räästalauale		52	4x40		
HS12	Screws for terrace edge board - Schrauben für terrassenbrett - Vis de fixation de lame de seuil d'entree de terrasse - Vite per unire delle assi del terrazzo - Schroeven voor terrashout - Kruvi terrassi servaliistule		7	4x40		
HS13	Screw for triangular fixing - Montagschraube für dreieckige - Vis d'assemblage pour triangle - Vite per fissaggio triangolare - Schroef voor driehoekig afdeklijst - Kruvi kolmnurga monteerimiseks seinale		10	4x60		
HS13	Screw for post - Schrauben für pfosten - Vis de fixation des poteaux - Viti per inviare - Schroef voor stijlen - Kruvi postile		2	4x60		
HS13	Screw for roof edge reinforcement - Schrauben für dachrandverstärkung - Vis pour fixation corniere renfort de bord de toit - Viti x rinforzo bordo tetto - Schroef voor dakrand versterking - Kruvi räästafugevdusele		18	4x60		
HS18	Screw for foundation - Schrauben zur befestigung fundament - Vis de fixations des poutrelles de fondations - Viti x fondamenta - Schroef voor fundering - Kruvi alusraamile		42	5x120		
HS18	Screw for fixing roof elements - Schraube für befestigung dachelementen - Vis de fixation des panneaux de toit - Vite per fissare gli elementi del tetto - Schroef voor bevestiging dakelement - Kruvi kilpide kinnitamiseks seinaga		48	5x120		
HS18	Screw for roof beams - Schrauben für dachbalken - Vis pour fixation pannes de toit - Viti per perline del tetto - Schroef voor gordingen / dakbalken - Kruvi pärtinittele		22	5x120		
HS18	Screw for wall details - Schraube für wand details - Vis pour mur details - Viti per elementi della porta - Schroef voor wand details - Kruvi seinadetailidele		25	5x120		
HS18	Screw for gable - Schrauben für giebel - Vis pour fixation des pignons - Viti per timpano - Schroef voor gevelpunt - Kruvi viilude kinnitamiseks		4	5x120		
HS16	Screw for 1. wall beam - Schraube für 1. bohlenreihe - Vis de fixations 1ere rangée de madriers avec poutrelles de fondations - Vite fissaggio alle fondamenta - Schroef voor 1 wandbalk - Kruvi poollauale		10	5x90		
HS16	Screw for foundation - Schrauben zur befestigung fundament - Vis de fixations des poutrelles de fondations - Viti x fondamenta - Schroef voor fundering - Kruvi alusraamile		6	5x90		
HS20	Screw for post height adjustment - Schrauben für regulierungsschraube für pfosten - Vis de fixation de support réglable de poteau - Viti per fissare ed aggiustare l'altezza del palo verticale - Schroef voor hoogte instelling stijlen - Kruvi vajumispidile		8	6x50		
HS21	Screw for fixing roof elements - Schraube für befestigung - dachelementen - Vis de fixation des panneaux de toit - Vite per fissare gli elementi del tetto - Schroef voor bevestiging dakelement - Kruvi kilpide montaažiks		120	6x80		
HS24	Screw for wall details - Schraube für wand details - Vis pour mur details - Viti per elementi della porta - Schroef voor wand details - Kruvi seinadetailidele		8	8x220		
NF2	Zn nail for floor fillet - Zn nagel für fussbodenleiste - Pointe pour corniere de finition du plancher - Chiodi x fissaggio pavimento - Spijker(nagel) voor vloer afdeklijst - Nael põrandaliistule		40	1.4x40		
SH40	Hammer block - Schlagholz - Calle de frappe - Blocco di legno da usare come cuscinetto quando si usa il martello - Stagklos - Löögiklots		1			
SFS	Nut for storm protection - Schraubenmutter für sturmleiste - Ecrou pour latte anti-tempete - Dado x asta protezione vento - Moer voor stromverankering - Mutter tormikinnitustiistule		12	D6		
NF3	Zn nail for terrace - Zn nagel für terrassenbretter - Pointe pour plancher de terrasse - Chiodo zincato per terrazza - Spijker(nagel) voor terrasyvloer - Nael terrassilauale		402	2.1x50		

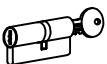
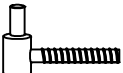

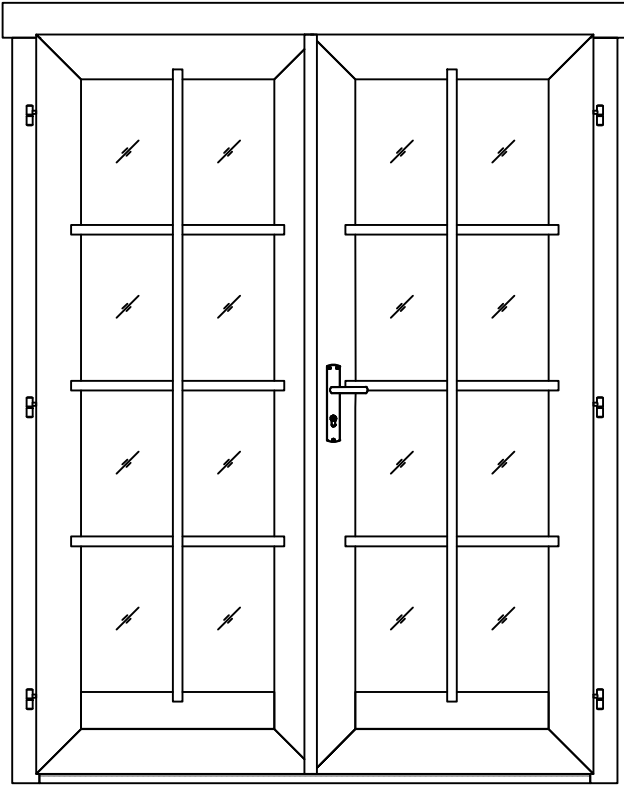
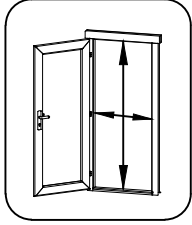
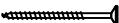
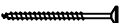
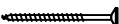
Pos	24.11.2017 Piece list - Stückliste - Liste des pièces - Elementi - Stuklijst - Tükitalabel 710x1224 AK.1.106.TSSP SGC	1/1	Q	P (mm)	L (mm)
<p data-bbox="260 145 1292 174">Glass size - Glasgröße - Taille de la vitre - Misura del vetro - Glas afmeting - Klaasi mõõt: 566x1080 mm</p> <div data-bbox="691 237 1015 757" style="text-align: center;">  </div> <div data-bbox="1337 145 1522 320" style="text-align: right;">  <p data-bbox="1369 342 1490 371">610x1124 mm</p> </div>					
FS1	Window handle fittings - Fenstergriff - Poignée de fenetre - Maniglia c/ferramenta - Raamhendel -/grendel -/klink - Aknalink		2		
FSP	Bolt for window handle fittings - Bolzen für fenstergriff beschlag - Vis pour fixation poignée de fenetre - Bullone x apertura manuale finestra - Schroef voor raamhendel - Akna käepideme polt		4		
HS1	Screw for georgian bars - Schraube für sprossen - Vis pour croisillons - Viti per unire la griglia georgiana della finestra - Schroeven voor raamverdeling - Krugi akna petfeliistule		6	2.5x20	

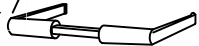
Pos	24.11.2017 Piece list - Stückliste - Liste des pièces - Elementi - Stuklijst - Tükitalabel 710x1224 AK.1.106.TSSV SGC	1/1	Q	P (mm)	L (mm)
	<p data-bbox="260 152 1289 183">Glass size - Glasgröße - Taille de la vitre - Misura del vetro - Glas afmeting - Klaasi mõõt: 566x1080 mm</p> <div data-bbox="691 241 1015 763" style="text-align: center;">  </div> <div data-bbox="1337 152 1522 327" style="text-align: right;">  <p data-bbox="1369 349 1490 376">610x1124 mm</p> </div>				
FS1	Window handle fittings - Fenstergriff - Poignée de fenetre - Maniglia c/ferramenta - Raamhendel -/grendel -/klink - Aknalink		2		
FSP	Bolt for window handle fittings - Bolzen für fenstergriff beschlag - Vis pour fixation poignée de fenetre - Bullone x apertura manuale finestra - Schroef voor raamhendel - Akna käepideme polt		4		
HS1	Screw for georgian bars - Schraube für sprossen - Vis pour croisillons - Viti per unire la griglia georgiana della finestra - Schroeven voor raamverdeling - Kruvi akna petfeliistule		6	2.5x20	

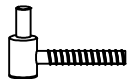
Pos	13.01.2017	Piece list - Stückliste - Liste des pièces - Elementi - Stuklijst - Tükitabel 835x1900 UL.2.100.IVP.MMd TC	1/1	Q	P (mm)	L (mm)
		  <p>735x1818 mm</p>				
HS25	Screw for doorstep - Schrauben für swelle - Vis pour fixation barre de seuil - Vite per soglia della porta - Schroef voor deurdorpel - Kruvi lävepakule		2	4.5x65		
HS16	Screw for door jamb - Schraube für türrahmen - Vis de fixation partie haute avec montants du cadre de porte - Viti x fissaggio montanti porte - Schroef voor deurkozijn - Kruvi ukse lengile		4	5x90		
TL4	Door handle fittings - Türgriff - Poignée de porte - Maniglie - Deurhendel / klink - Ukse käepide		1			
TL5	Set of door lock covers - Schlossblenden - Set de garnitures de porte - Copertura serrature - Slot sluitplaat set - Ukse lukuplaat		1			
	Cylinder lock - Zylinderschloss - Barillet de porte - Serratura - Cylinder slot - Ukse lukusüdamik		1	30x35		
	Male bolt hinge for door - Türband - Partie male de paumelle de porte - Cerniera anube x porta - Scharnier bout - Ukse poithing isane		3			

Pos	24.11.2017 Piece list - Stückliste - Liste des pièces - Elementi - Stuklijst - Tükitalabel 1494x1957 TUK.1.108.TSVP.MMb SGC	1/1	Q	P (mm)	L (mm)
	Glass size - Glasgröße - Taille de la vitre - Misura del vetro - Glas afmeting - Klaasi mõõt: 514x1593 mm				
	  <p>1394x1873 mm</p>				
HS1	Screw for georgian bars - Schraube für sprossen - Vis pour croisillons - Viti per unire la griglia georgiana della finestra - Schroeven voor raamverdeling - Krugi ukse peffeliistule		16	2.5x20	
HS4	Screw for door fillet - Schraube zur befestigung türleiste - Vis pour fixation baguette d'arret de porte - Viti per massellino della porta - Schroef voor deurlijst - Krugi ukse kokkuvattsiliistule		5	3x30	
HS16	Screw for door jamb - Schraube für türrahmen - Vis de fixation partie haute avec montants du cadre de porte - Viti x fissaggio montanti porte - Schroef voor deurkozijn - Krugi ukse lengile		4	5x90	
HS25	Screw for doorstep - Schrauben für swelle - Vis pour fixation barre de seuil - Vite per soglia della porta - Schroef voor deurdorpet - Krugi lävepakule		3	4.5x65	
TL4	Door handle fittings - Türgriff - Poignee de porte - Maniglie - Deurhendel / klink - Ukse käepide		1		
TL5	Set of door lock covers - Schlossblenden - Set de garnitures de porte - Copertura serrature - Slot sluitplaat set - Ukse lukuplaat		1		
	Cylinder lock - Zylinderschloss - Barillet de porte - Serratura - Cylinder slot - Ukse lukusüdamik		1	30x35	
	Male bolt hinge for door - Türband - Partie male de paumelle de porte - Cerniera anube x porta - Scharnier bout - Ukse polthing isane		6		
	Striker for barrel bolt - Hülse für grendelriegel - Gache au sol du targette - Boccola per fermo della porta - Huls voor vergrendelingsschuif - Vasturaud ukse servariivile		2		