

Name	Hansa Corner B 360x570+VD+Terr 44	
Zeichnung/Drawing	WAND/WALL A	
Profil/Profile	4.4x13.5	Datum/Date 17.10.2016

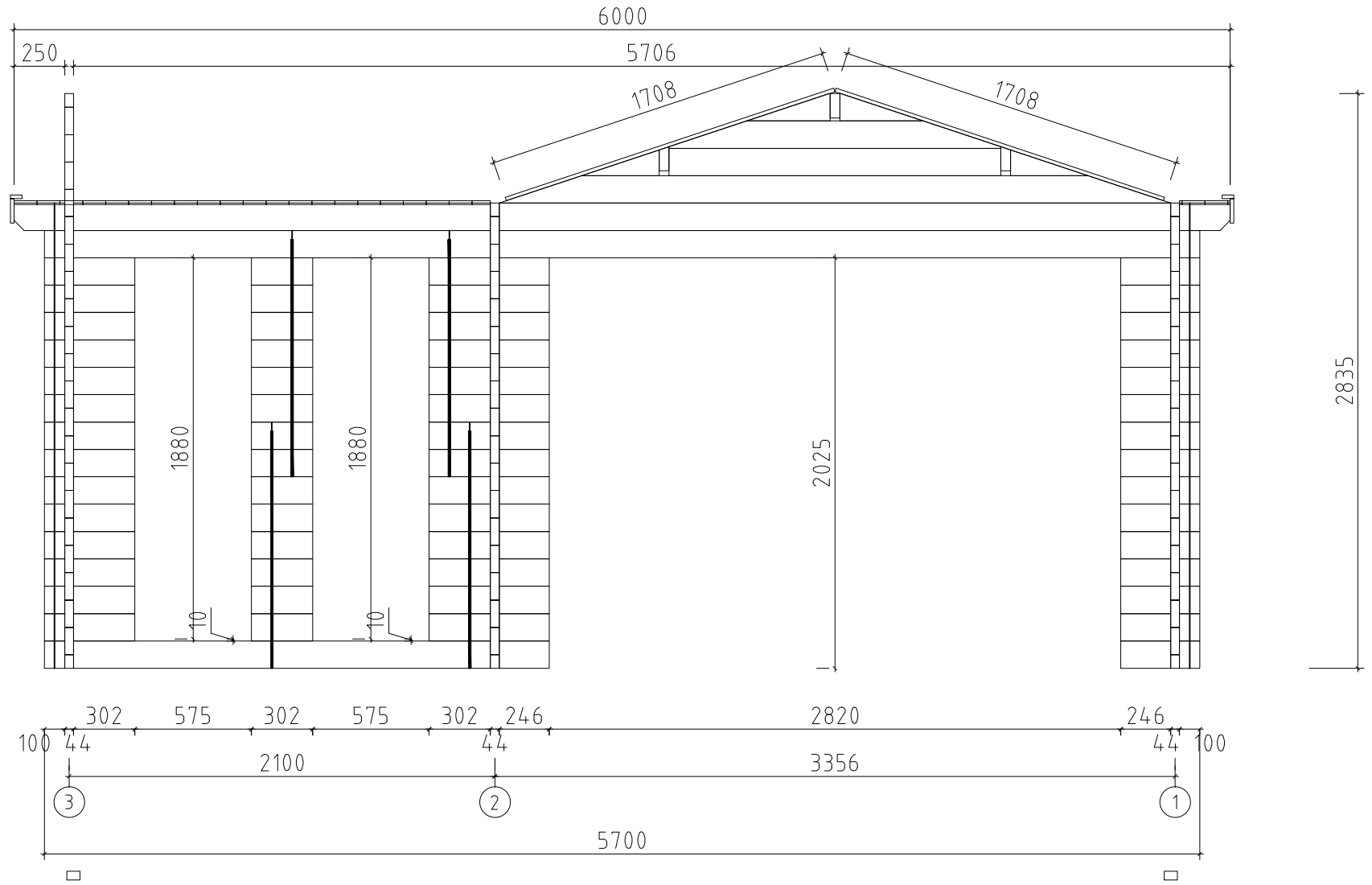

Wand/Wall B ↗

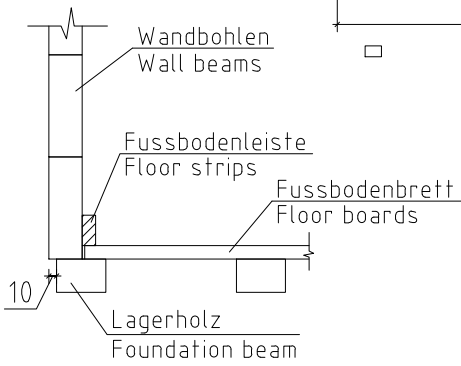

Name	Hansa Corner B 360x570+VD+Terr 44	
Zeichnung/Drawing	WAND/WALL B	
Profil/Profile	4.4x13.5	Datum/Date 17.10.2016

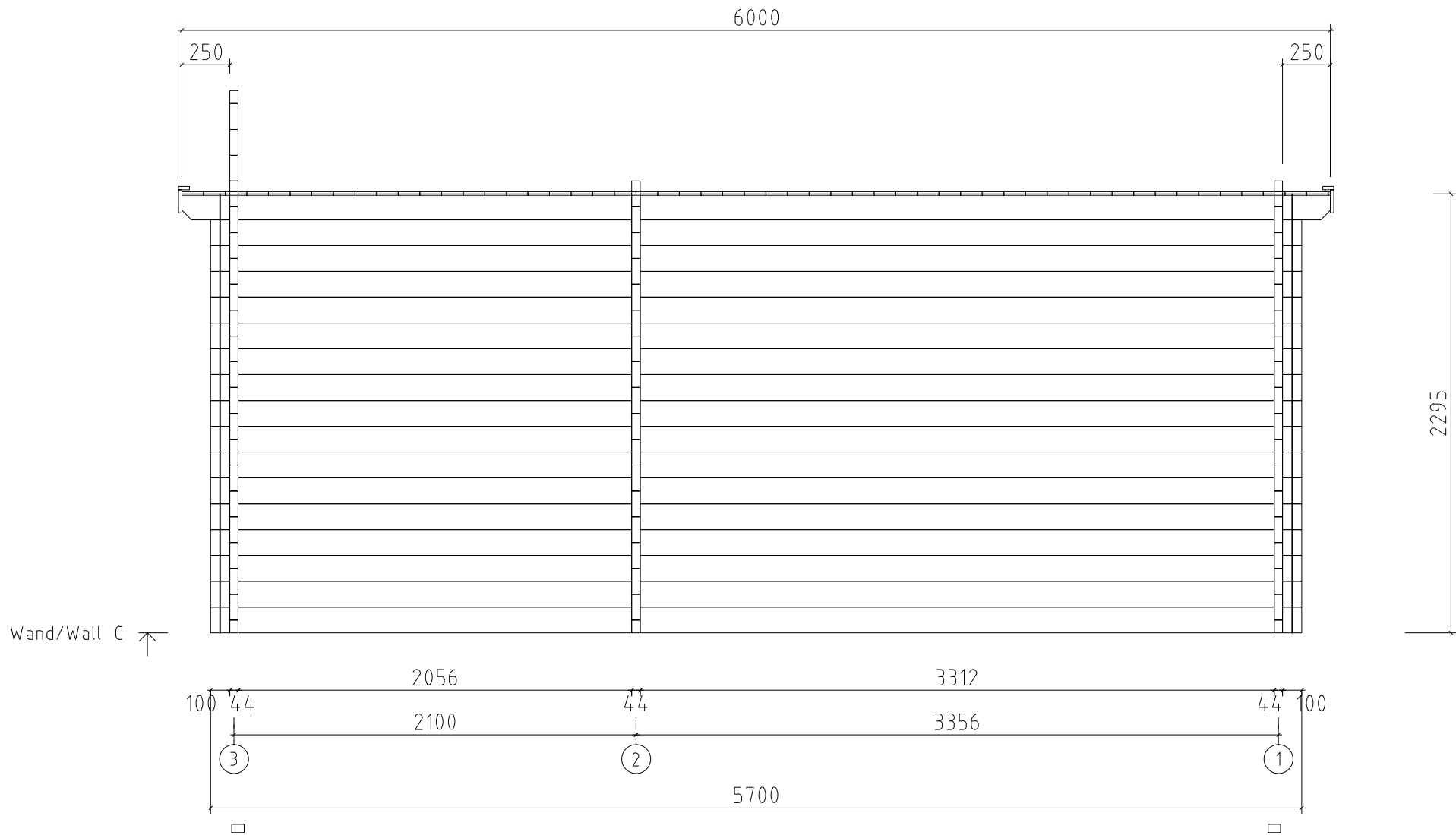

Name	Hansa Corner B 360x570+VD+Terr 44	
Zeichnung/Drawing	WAND/WALL C	
Profil/Profile	4.4x13.5	Datum/Date 17.10.2016

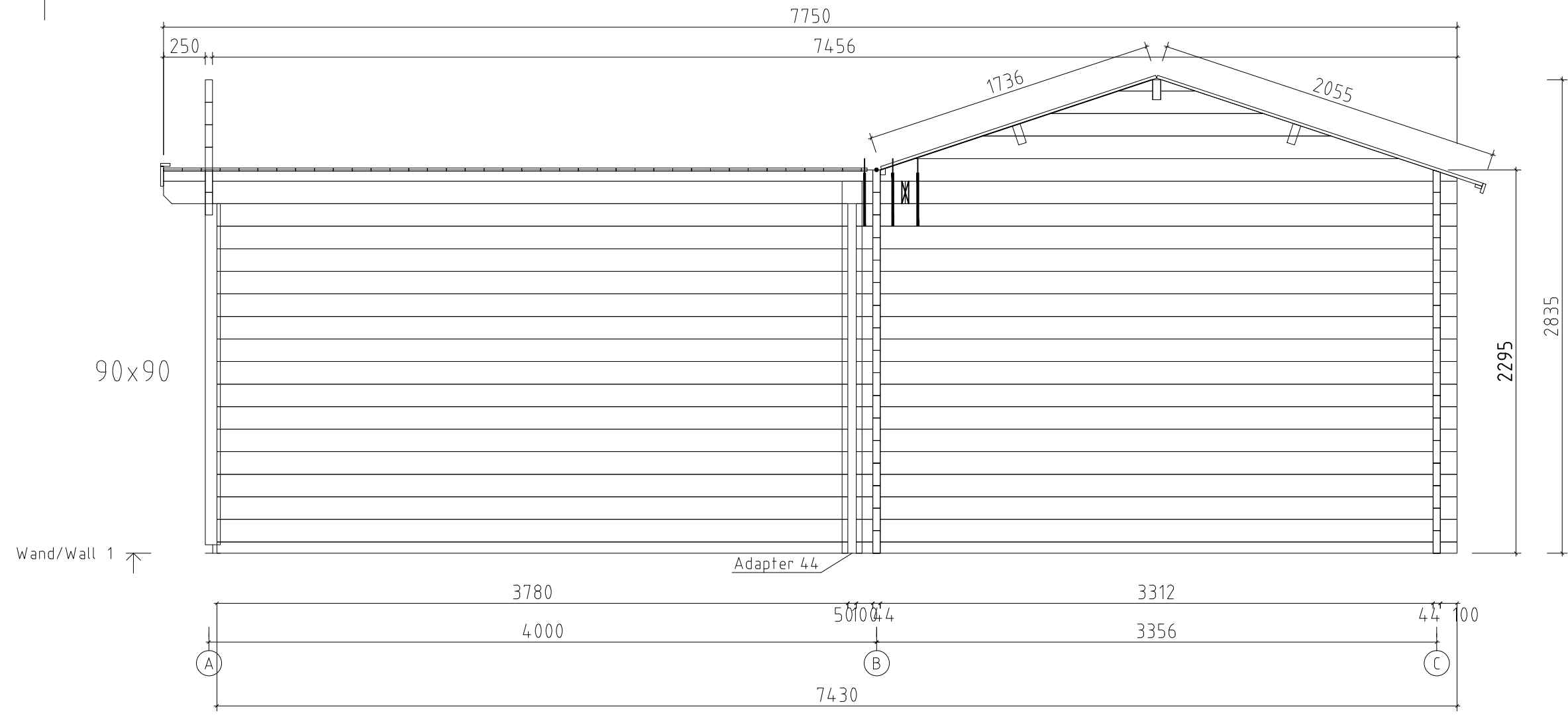
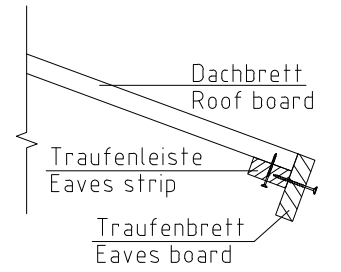
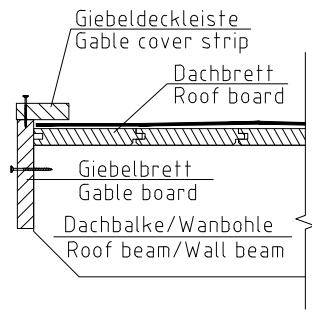

Name	Hansa Corner B 360x570+VD+Terr 44		
Zeichnung/Drawing	WAND/WALL 1		
Profil/Profile	4.4x13.5	Datum/Date	17.10.2016

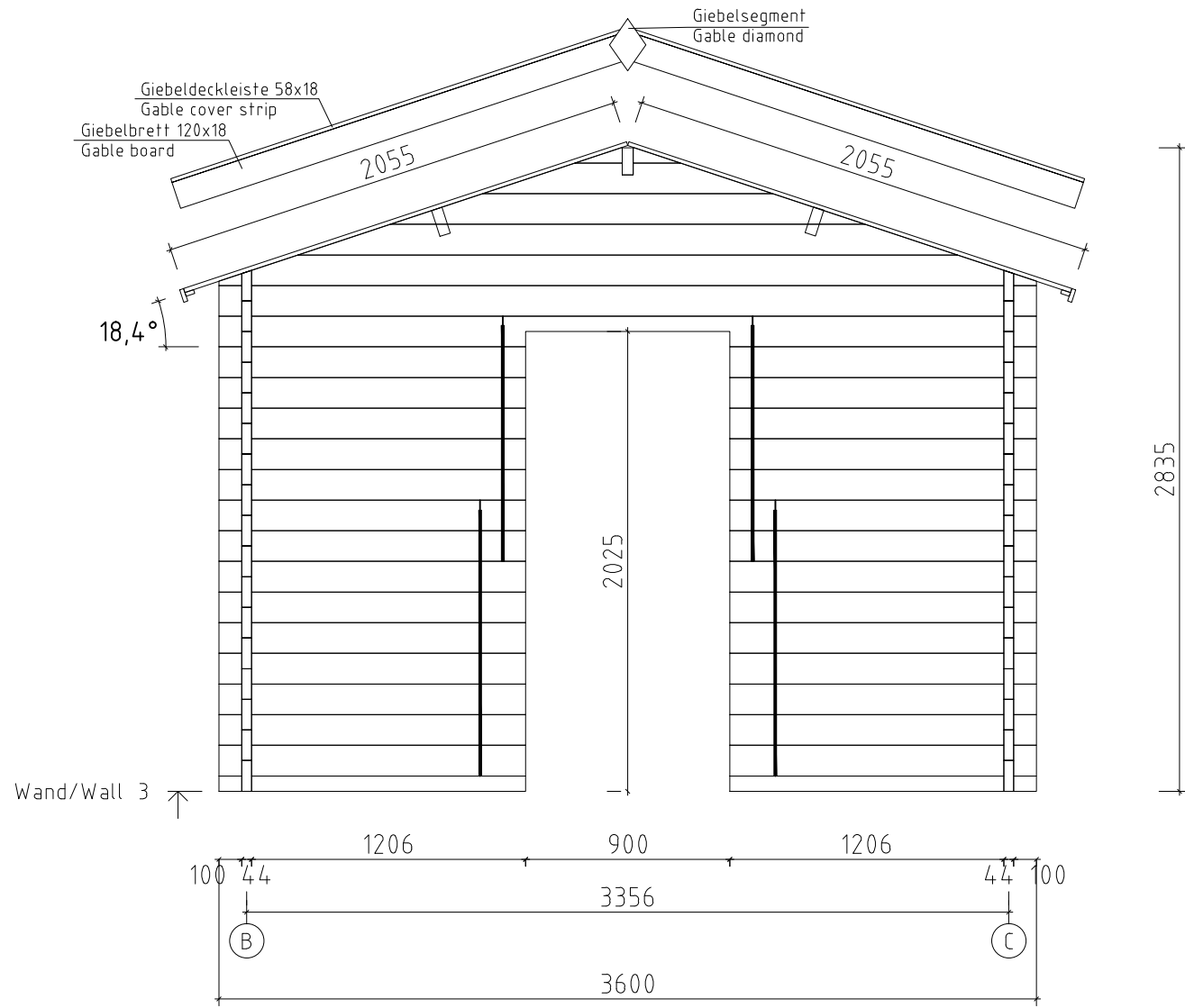

Name	Hansa Corner B 360x570+VD+Terr 44		
Zeichnung/Drawing	WAND/WALL 3		
Profil/Profile	4.4x13.5	Datum/Date	17.10.2016