









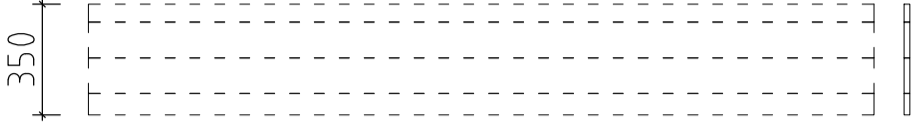
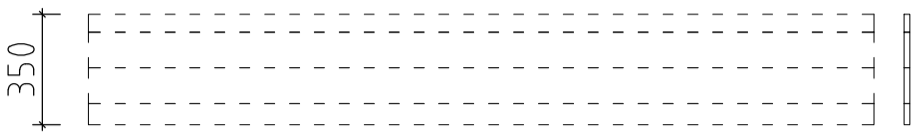
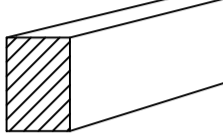
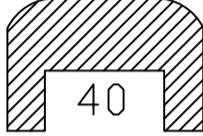

Pos	Teileliste/Specification lan C 500x410+SD 50		Stck Pcs.	Profil Profile (mm)	Länge Length (mm)
001			1	50x130	5600
002			1	50x130	5600
003			1	50x130	5400
004			3	50x130	5200
005			1	50x130	5000
006			1	50x130	5000
007			1	50x130	5000
008			17	50x130	5000
009			21	50x130	4100
010			2	50x65	4100
011			1	50x130	4100
012			1	50x130	4100
013			6	50x130	3065
014			3	50x71	2575
015			18	50x130	1249
016			9	50x130	806
017			7	50x130	656
018			2	50x130	656
019			15	50x130	450
FH2	FUNDAMENTHOLZ (imprägniert) - FOUNDATION BEAM (impregnated)		2	68x94	4644
FH1	FUNDAMENTHOLZ (imprägniert) - FOUNDATION BEAM (impregnated)		2	68x94	3880
FH3	FUNDAMENTHOLZ (imprägniert) - FOUNDATION BEAM (impregnated)		5	44x94	4644
DB1	DACHBALKE - ROOF BEAM		5	58x170	5600
	DACHBRETTER - ROOF BOARDS		50+1	113x18	5150
	FUSSBODENBRETTER- FLOOR BOARDS		42+1	113x28	3795
Kood	lanC 500x410+SD 50	Materjal	File	lan C 500x410+SD 50.dwg	Leht 1/3

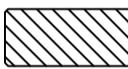
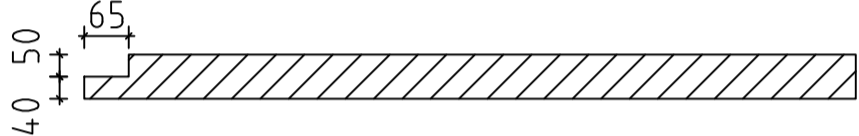
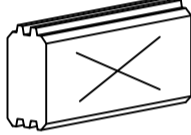
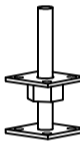
Pos	Teileliste/Specification lan C 500x410+SD 50		Stck Pcs.	Profil Profile (mm)	Länge Length (mm)
	ABDECKLEISTEN - CEILING TRIMS		✓	15x28	22,0 lfm/rm
	FUSSBODENLEISTE - FLOOR STRIPS		✓	14x55	17,0 lfm/rm
BL-1	DACHBLENDEN - PARAPET 350mm		2	18x350	5235
BL-2	DACHBLENDEN - PARAPET 350mm		2	18x350	5600
BS-1	DACHBLENDEN- Blendenstützen - PARAPET- Parapet support 44x65		8	44x65	200
UPB-1	DACHBLENDEN- U-Profil für Blenden - PARAPET- U-Profile		✓	65x44	22,0 lfm/rm
DPL-1	DACHPAPPENLEISTE - ROOFING FELT STRIPS 15x28		✓	15x28	16,0 lfm/rm
T4-1	TRAUFENLEISTE - EAVES STRIPS 40x18		✓	40x18	12,0 lfm/rm
SP2-1	STÜTZPFOSTE - SUPPORT POST 90x90		✓	90x90	2145
SH	SCHLAGHÖLZER - MOUNTING PIECES		3		
VP2	Verstellbare Pfostenstütze - Adjustable post support M16		3	M16	
KL1	Metallstange - Metal bar M10		2	M10	1390
KL2	Metallstange - Metal bar M10		1	M10	1260
KL3	Metallstange - Metal bar M10		1	M10	1130
KL4	Gewindestange - Threaded Rod M8		4	M8	2000
KL5	Gewindestange - Threaded Rod M8		2	M8	435
KL6	Gewindestange - Threaded Rod M8		2	M8	305
	Mutter - nut M8 U-Scheibe - washer Ø25		8	M8	
	Befestigungsmutter - fixing nut M8		4	M8	
NG3	DACHPAPPNÄGEL - ROOFING NAILS 2.0x18		585		
NG1	NÄGEL - NAILS 2.5x50	Dachbretter - Roof boards		700	
NG2	NÄGEL - NAILS 2.5x60	Fussbodenbretter - Floor boards		588	
SR1	SCHRAUBEN - SCREWS 3.0x30	Abdeckleisten - Ceiling trims Fussbodenleiste - Floor strips Dachpappenleiste - Roofing felt strips Traufenleiste - Eaves strips		136	
SR3	SCHRAUBEN - SCREWS 3.5x45	U-Profil - U-Profile Türleisten - Door strips		124	
Kood	lanC 500x410+SD 50	Materjal	File	lan C 500x410+SD 50.dwg	Leht 2/3

Pos	Teileliste/Specification lan C 500x410+SD 50		Stck Pcs.	Profil Profile (mm)	Länge Length (mm)
SR8	SCHRAUBEN - SCREWS 5.0x70	Blendenbefestigung - Parapet fastening 	72		
SR9	SCHRAUBEN - SCREWS 5.0x100	Fundamenthölzer - Foundation beams 	28		
	DACHPAPPE - ROOFING FELT	 ✓		6,3m-7st.	45,0 lfm/rm
	FENSTER/WINDOW 1543x1146		2	A5-71	
	TÜR/DOOR 1425x1955	DIN rechts/right handed	1	TU3-GH+	
	✓ - Bitte selber anpassen (falls nötig)! / Cut into length on site (if needed)!				
Kood	lan C 500x410+SD 50	Materjal	File	lan C 500x410+SD 50.dwg	Leht 3/3

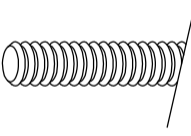
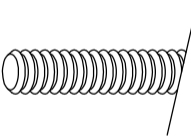
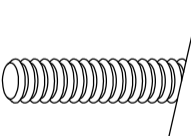
Spezifikation für Fenster und Türen/ Specifikation for windows and doors

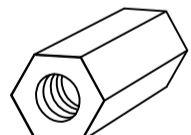
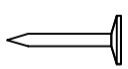
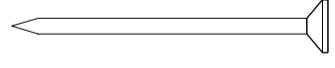
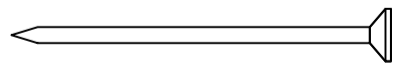
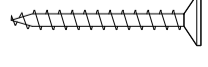
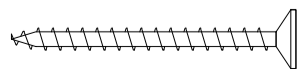
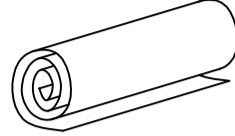
Ian C 500x410+SD 50

FENSTER/WINDOW 1543x1146 A5-71 2 Stck./Pcs.

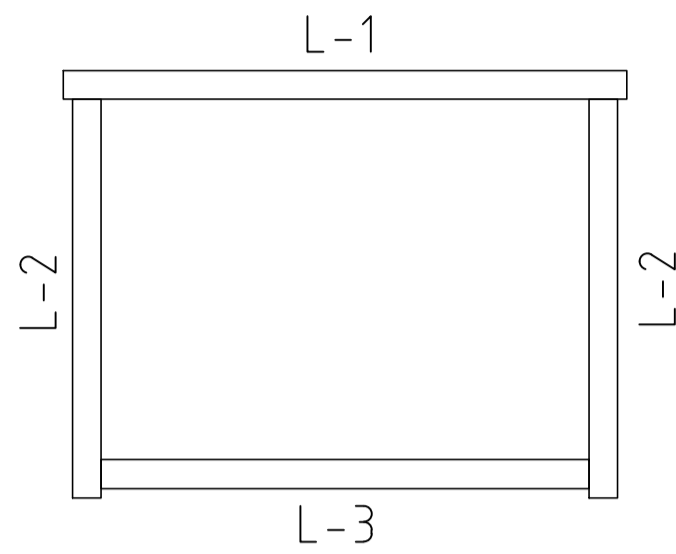
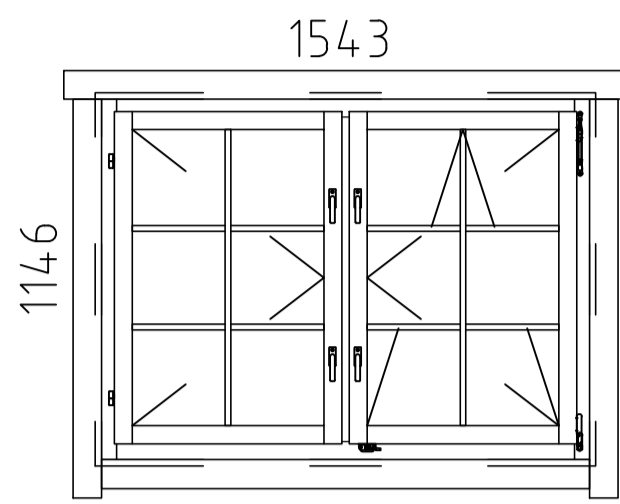

Die Leisten für eine Fenster/Strips for 1 window

L-1	18x90	L=1785mm	2 Stck./Pcs.
L-2	18x90	L=1260mm	4 Stck./Pcs.
L-3	18x90	L=1543mm	2 Stck./Pcs. ✓

TÜR/DOOR 1425x1955 TU3-GH+ 1 Stck./Pcs. DIN rechts/right handed

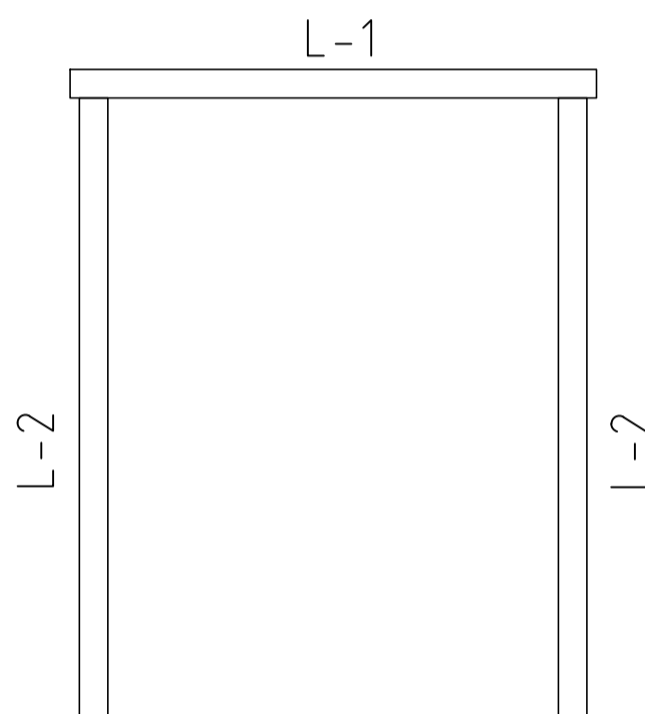
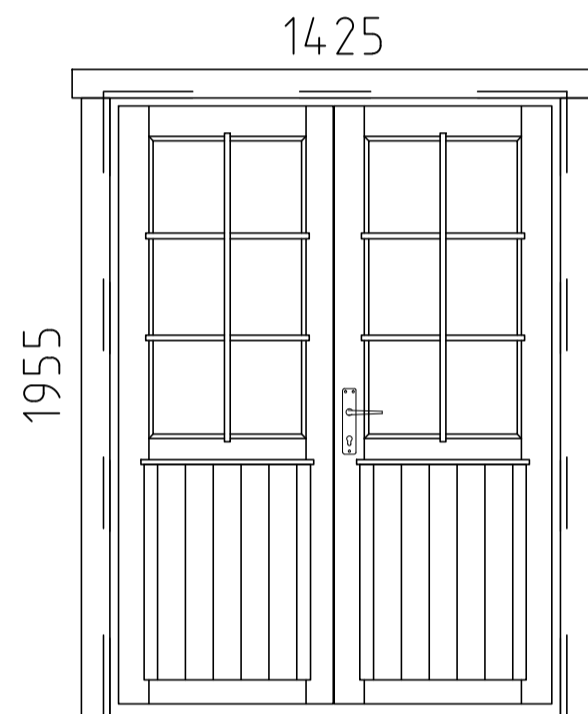

Die Leisten für eine Tür/Strips for 1 door

L-1	18x90	L=1665mm	2 Stck./Pcs.
L-2	18x90	L=1955mm	4 Stck./Pcs. ✓