

Wand/Wall A ↗

Name		Lucas D 320x320+VD+Terr_44	
Zeichnung/Drawing		WAND/WALL A	
Blatt/Sheet	2	Profil/Profile	4.4x13.5
		Datum/Date	24.05.2016

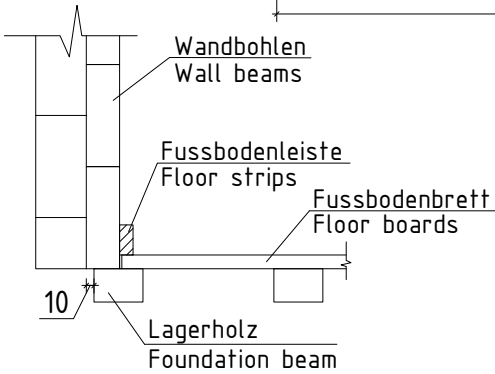

Name	Lucas D 320x320+VD+Terr_44		
Zeichnung/Drawing	WAND/WALL B		
Blatt/Sheet	3	Profil/Profile	4.4x13.5
		Datum/Date	24.05.2016

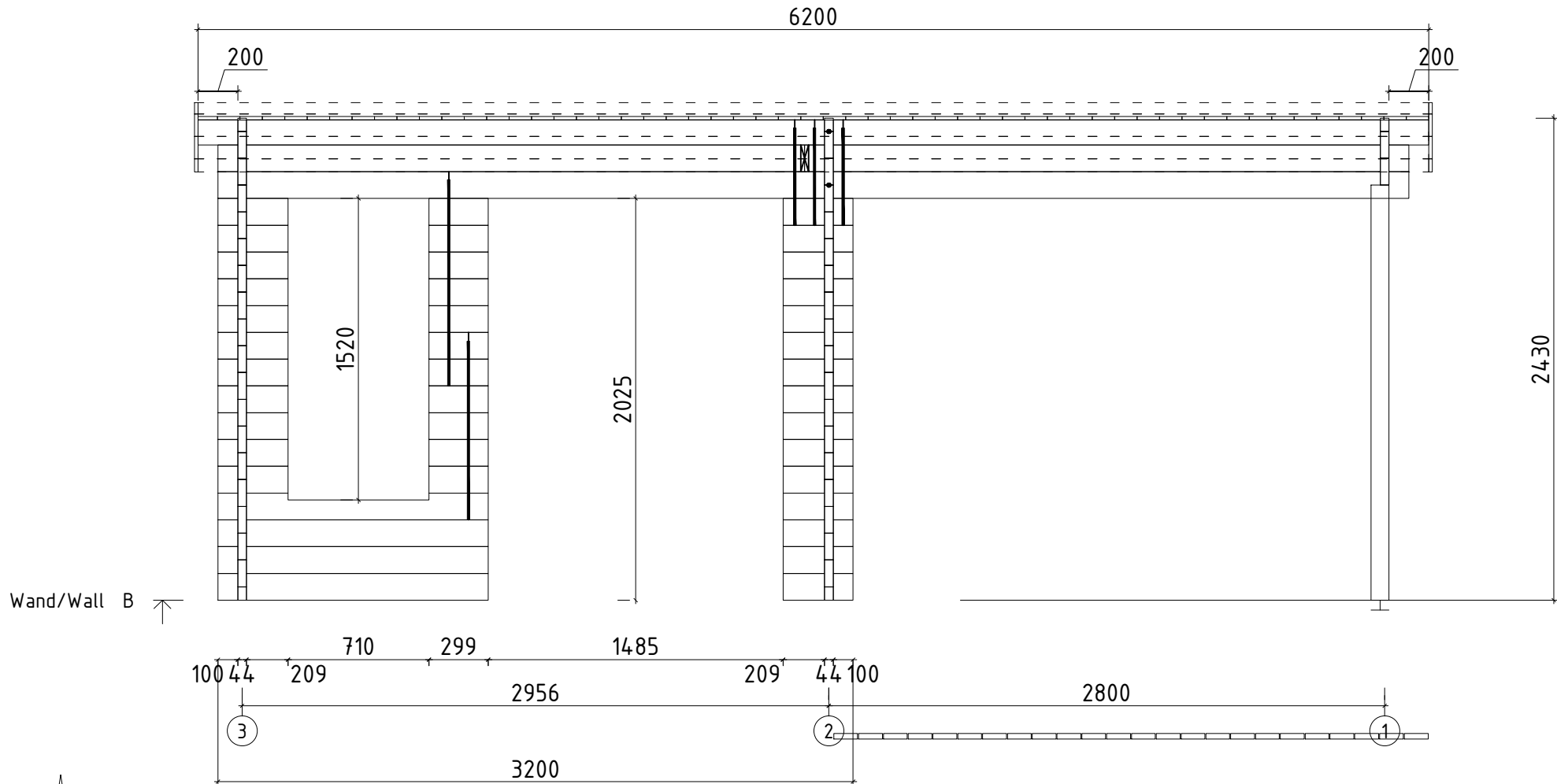
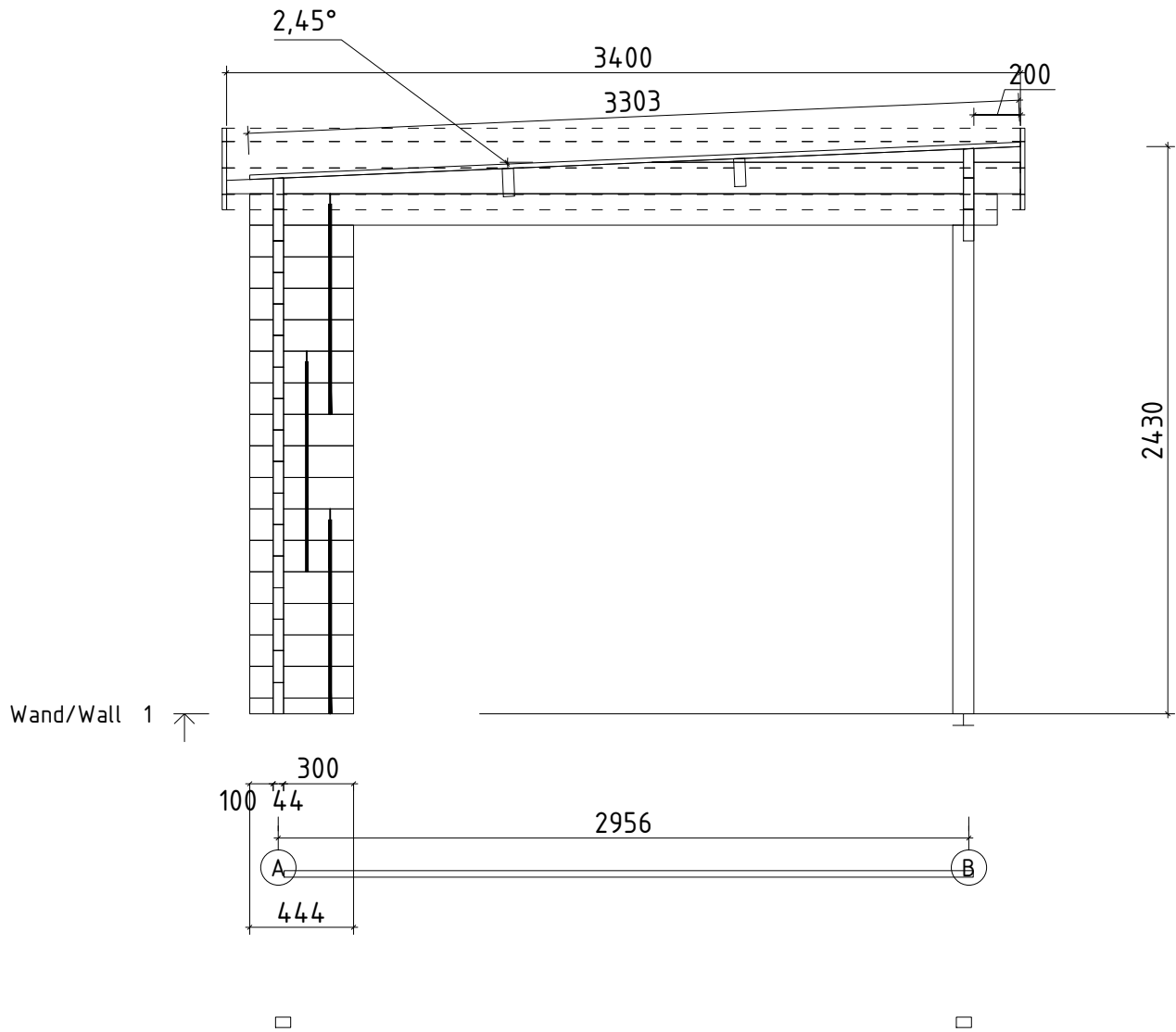

Name		Lucas D 320x320+VD+Terr_44	
Zeichnung/Drawing		WAND/WALL 1	
Blatt/Sheet	4	Profil/Profile	4.4x13.5
		Datum/Date	24.05.2016

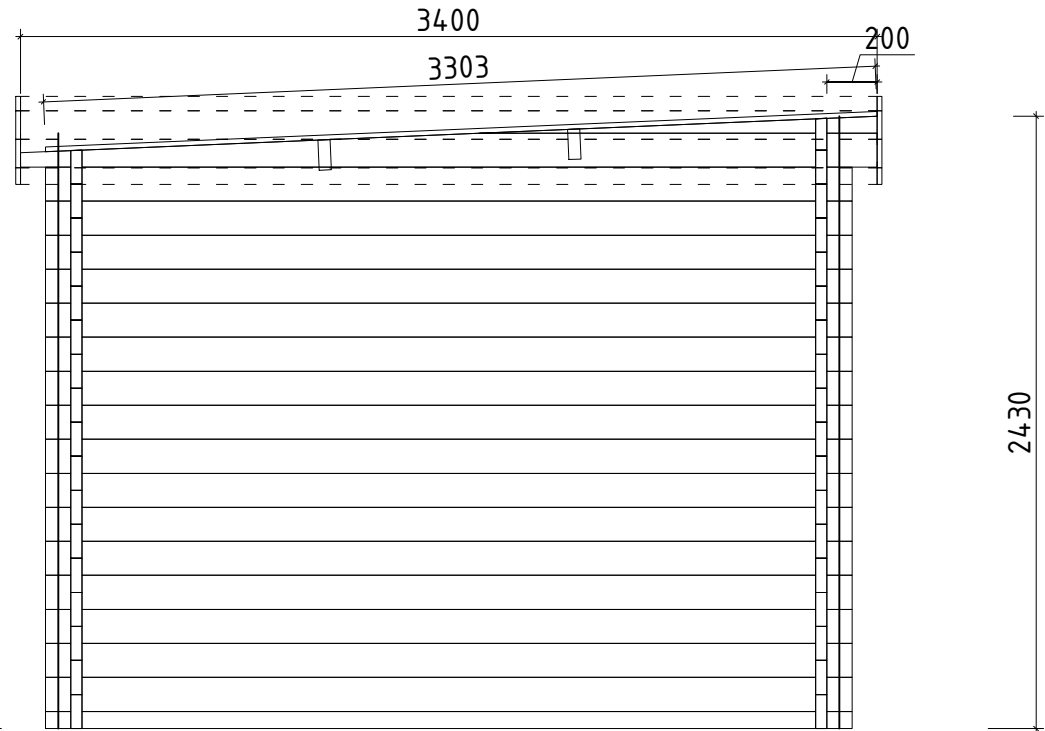

Wand/Wall 2 ↑

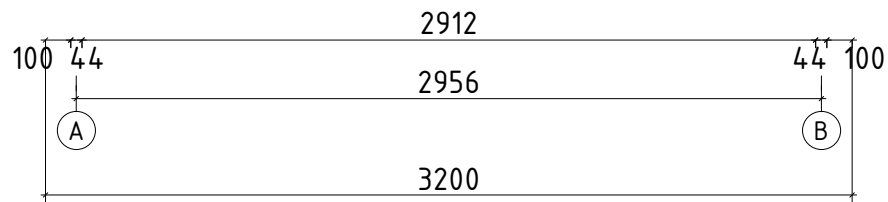

Parapet

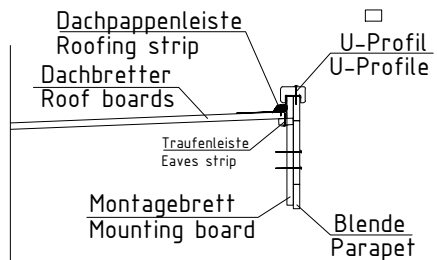
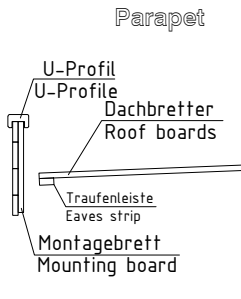

Name		Lucas D 320x320+VD+Terr_44	
Zeichnung/Drawing		WAND/WALL 2	
Blatt/Sheet	5	Profil/Profile	4.4x13.5
Datum/Date		24.05.2016	

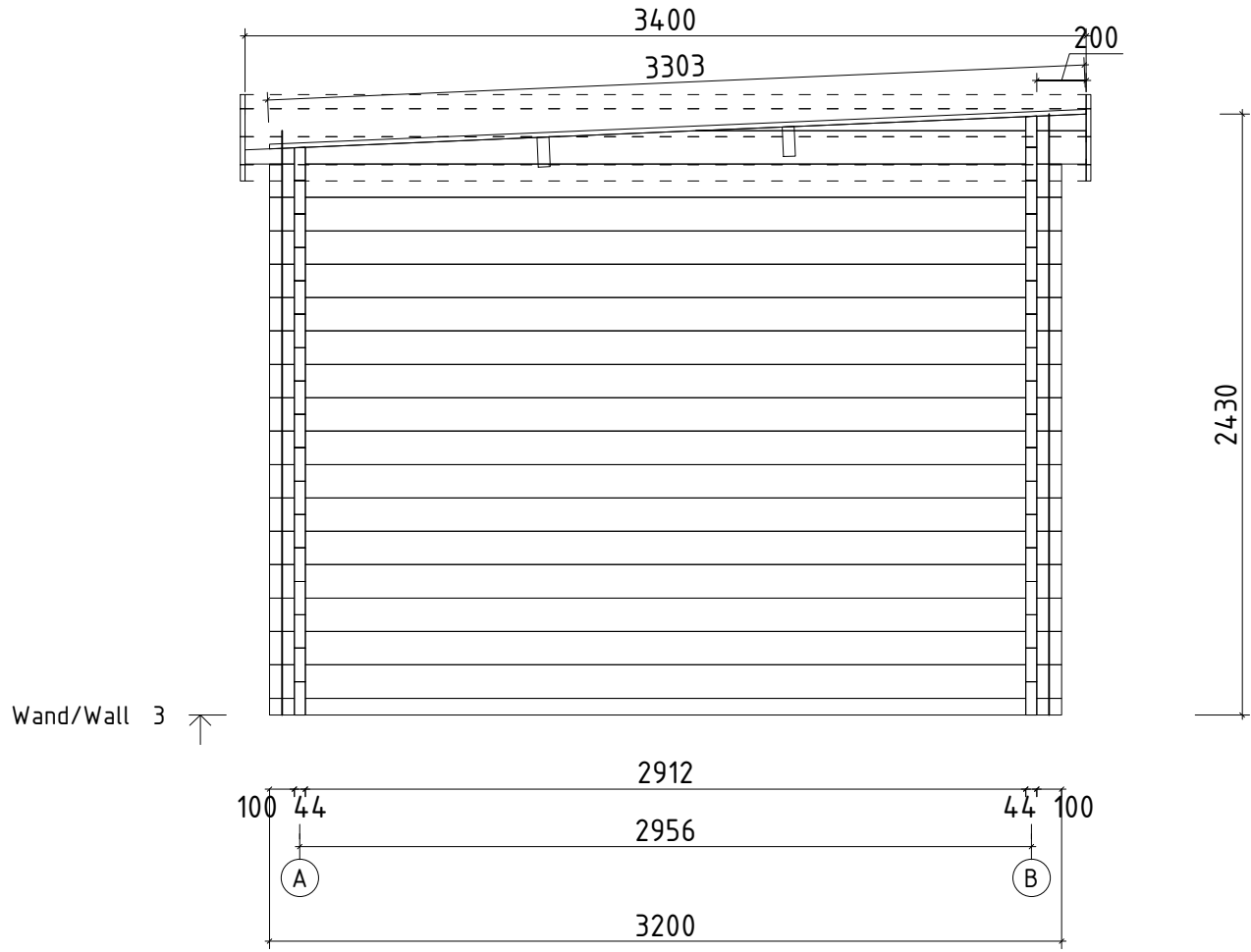

Name		Lucas D 320x320+VD+Terr_44	
Zeichnung/Drawing		WAND/WALL 3	
Blatt/Sheet	6	Profil/Profile	4.4x13.5
		Datum/Date	24.05.2016