

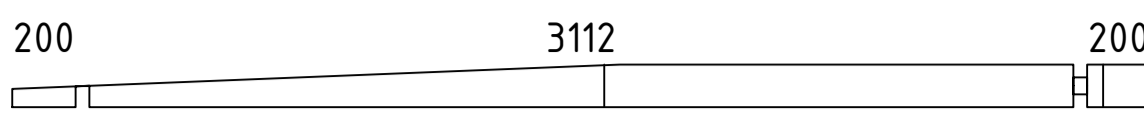

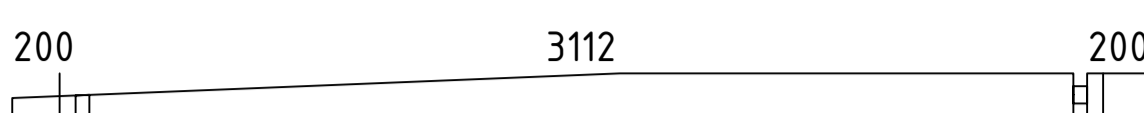

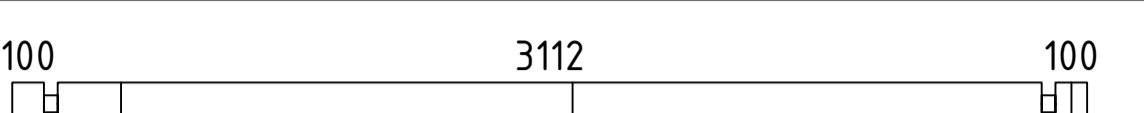

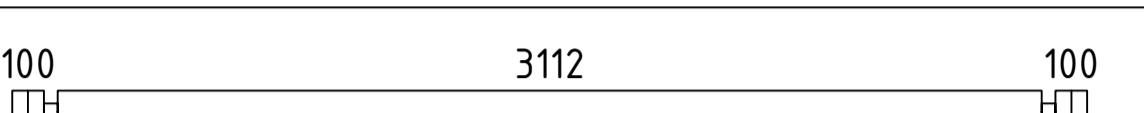

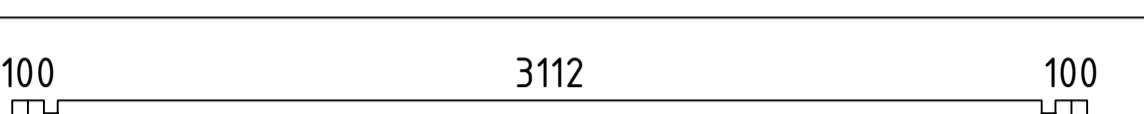
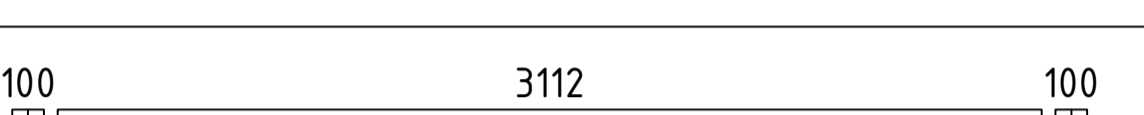
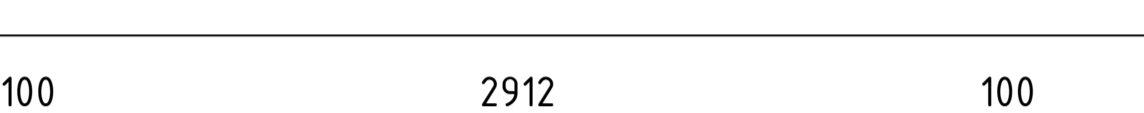
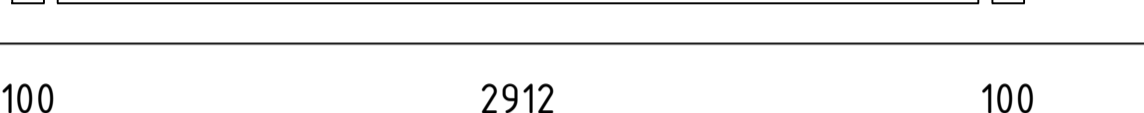
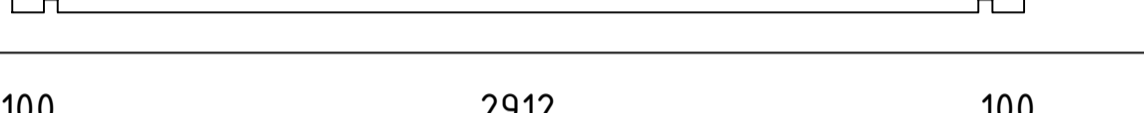
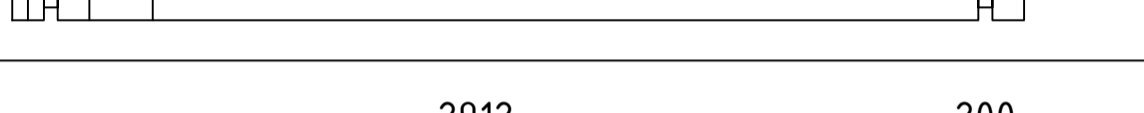
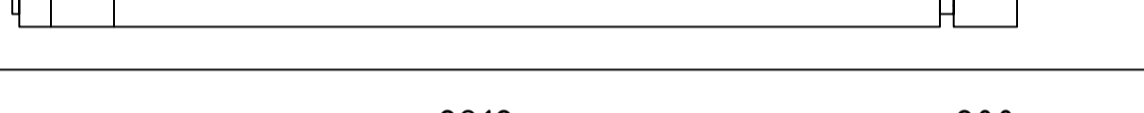
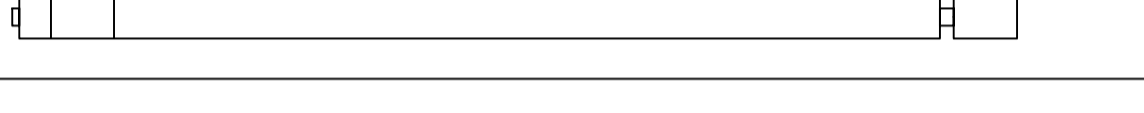
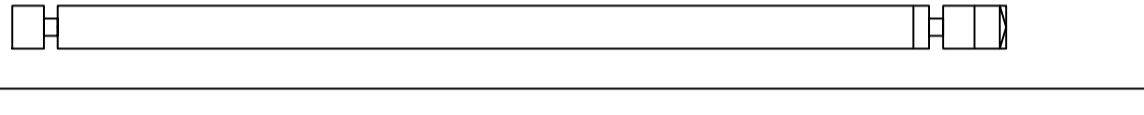
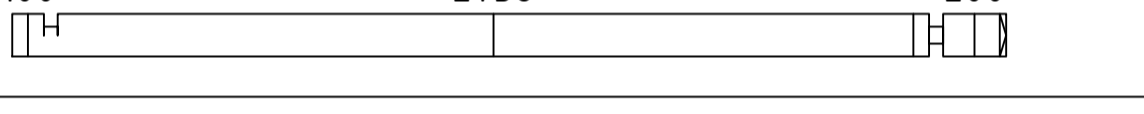
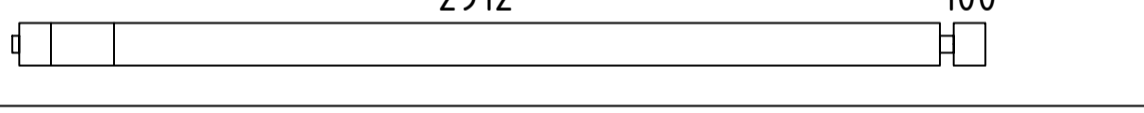
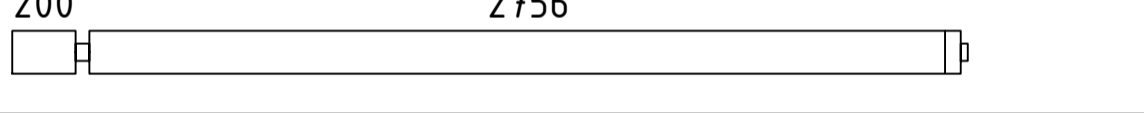
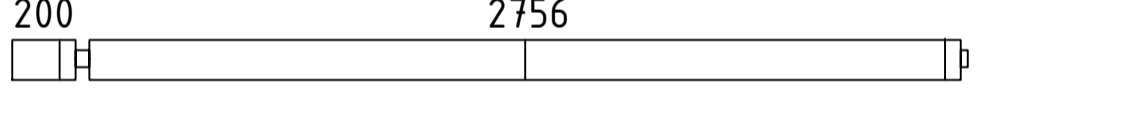
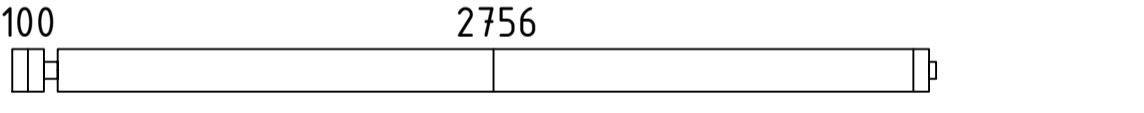
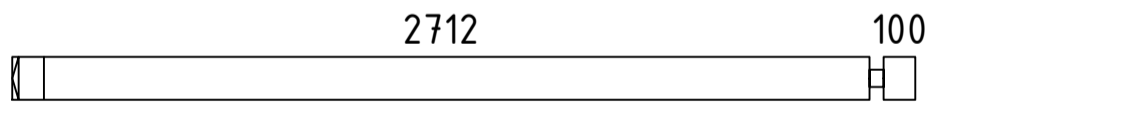
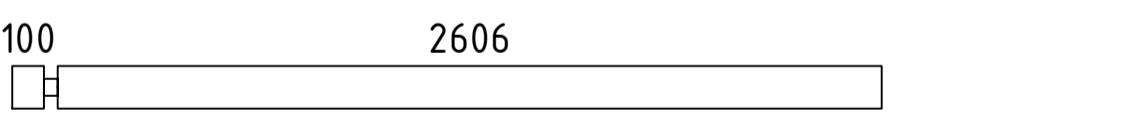
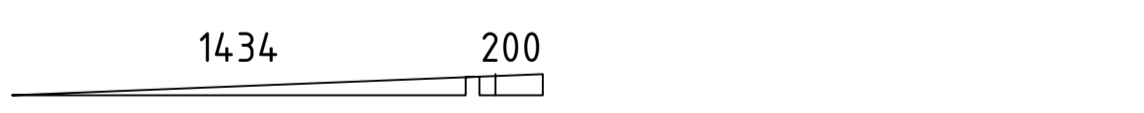

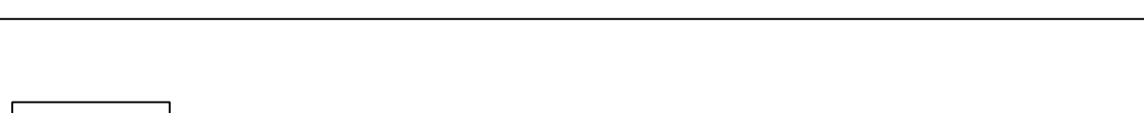
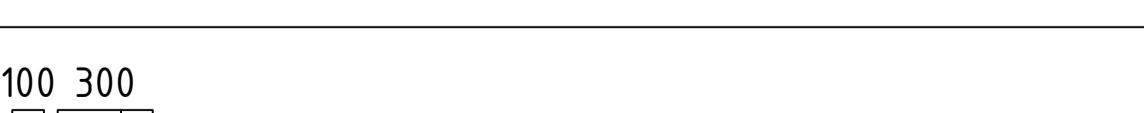
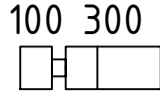
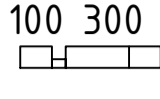
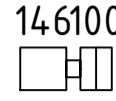
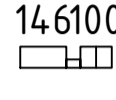
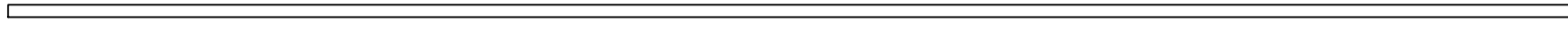

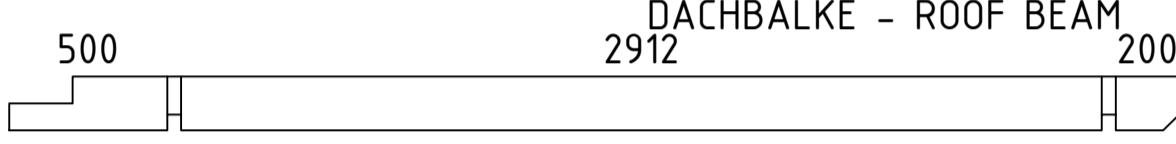
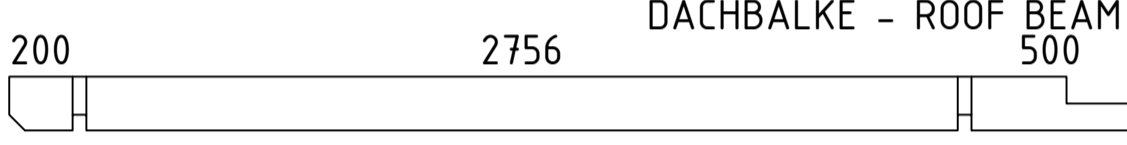
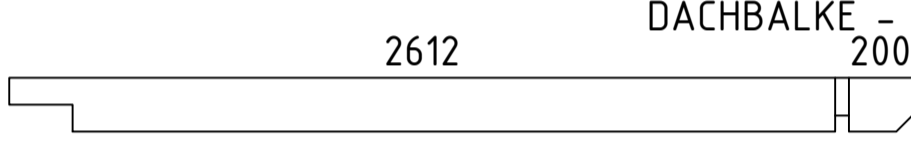
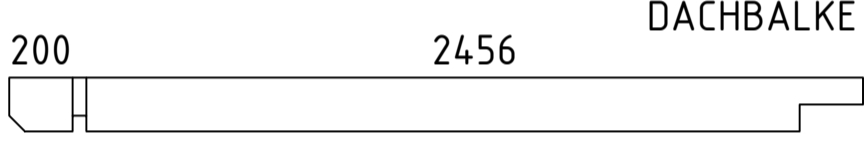
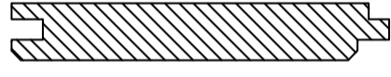
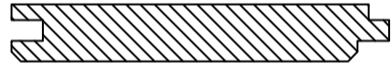
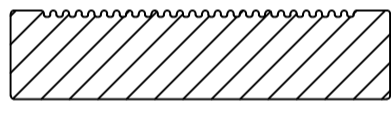
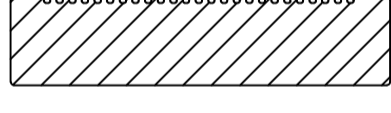
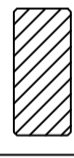
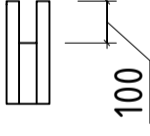
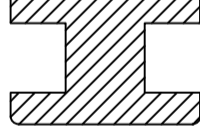
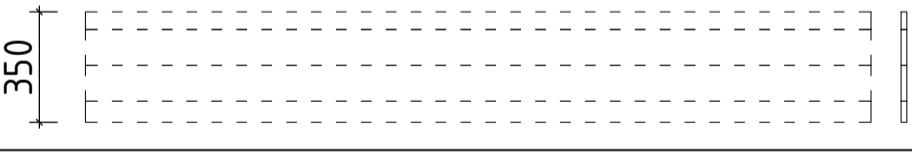
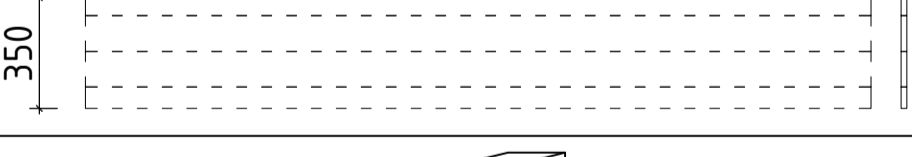
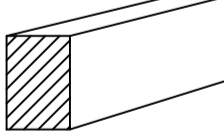
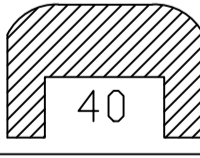
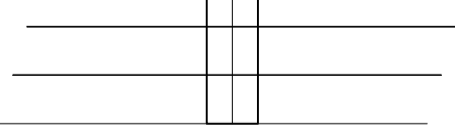

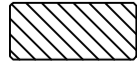
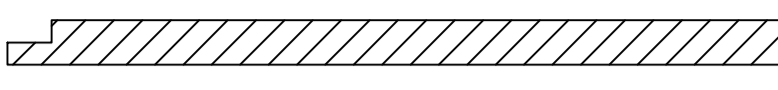
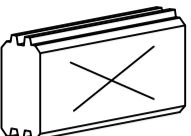
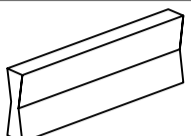
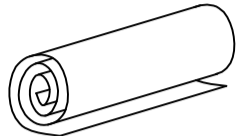
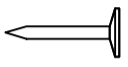
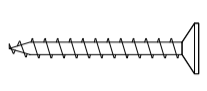
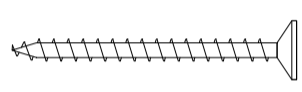
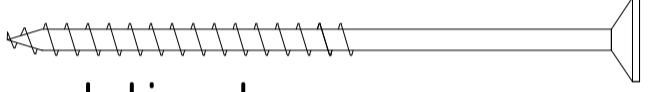
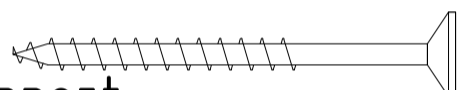
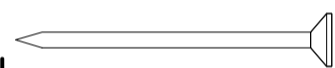
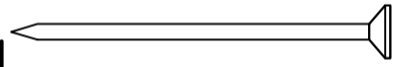
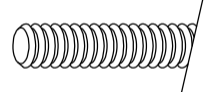
Pos	Teieliste/Specification Lucas E 340x320+VD+Terr_44	Stck. Pcs.	Profil Profile (mm)	Länge Length (mm)
001		1	44x135	3600
002		2	44x135	3600
003		1	44x135	3400
004		17	44x135	3400
005		1	44x135	3400
006		1	44x68	3400
007		1	44x135	3200
008		17	44x135	3200
009		1	44x135	3200
010		1	44x127	3178
011		1	44x135	3178
012		1	44x135	3144
013		1	44x135	3144
014		1	44x135	3078
015		1	44x135	3022
016		1	44x127	3022
017		1	44x135	2922
018		2	44x135	2856
019		15	44x135	2750
020		3	44x68	1678
021		21	44x135	641
022		1	44x135	641
023		11	44x135	498
024		9	44x135	444
025		4	44x135	444

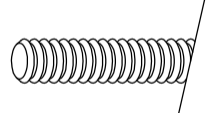
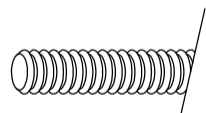
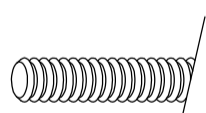
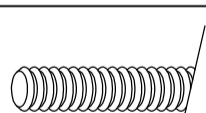
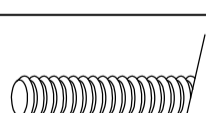
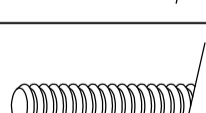
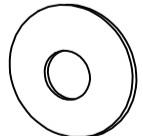
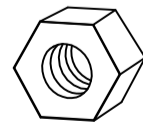
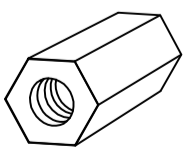
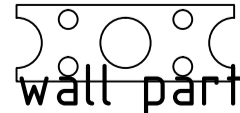
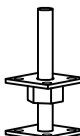
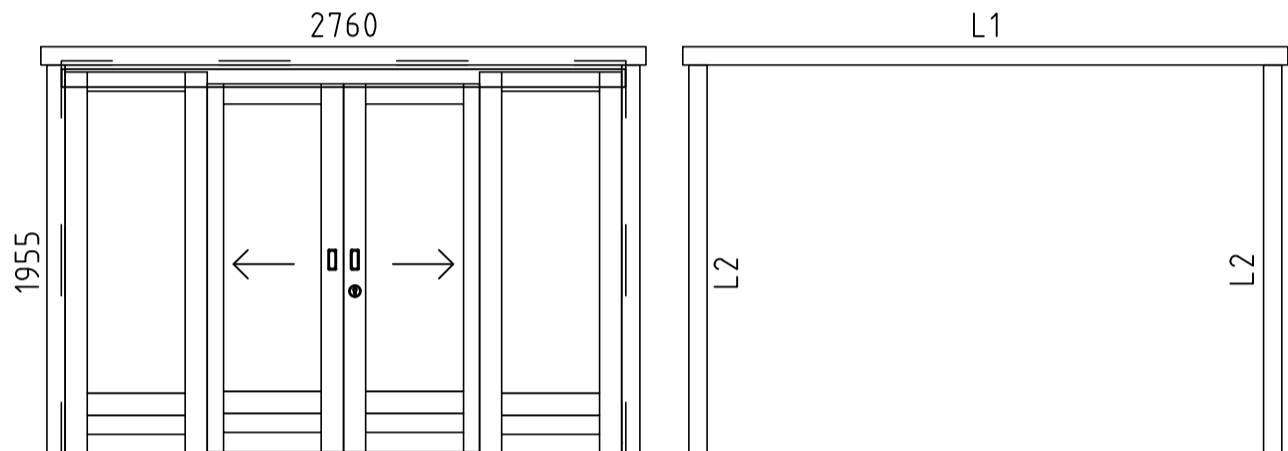
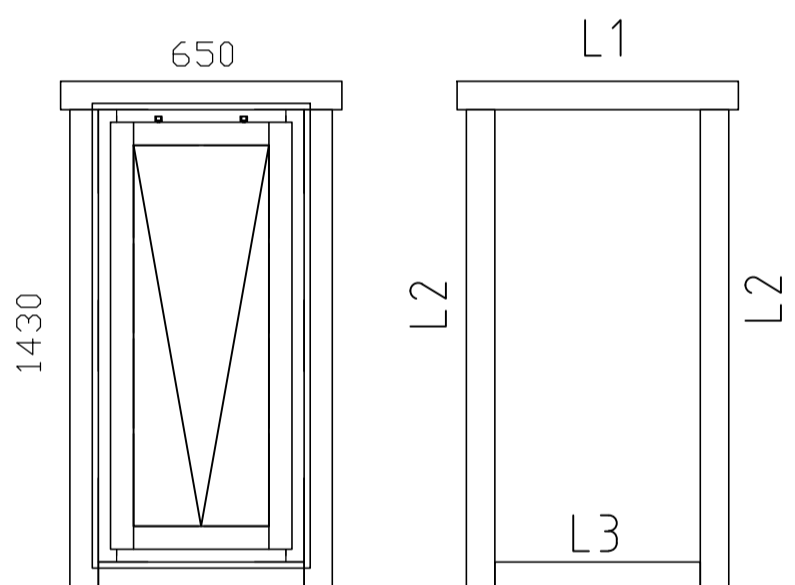
Pos	Teileliste/Specification Lucas E 340x320+VD+Terr_44		Stck. Pcs.	Profil Profile (mm)	Länge Length (mm)
026			2	44x135	444
027			1	44x68	444
028			28	44x135	290
029			2	44x68	290
FH1	FUNDAMENTHOLZ (imprägniert) - FOUNDATION BEAM (impregnated) 		2	65x44	5650
FH2	FUNDAMENTHOLZ (imprägniert) - FOUNDATION BEAM (impregnated) 		2	65x44	3180
FH3	FUNDAMENTHOLZ (imprägniert) - FOUNDATION BEAM (impregnated) 		10	65x44	3050
DB2	DACHBALKE - ROOF BEAM 		2	58x170	3700
DB3	DACHBALKE - ROOF BEAM 		1	58x170	3544
DB4	DACHBALKE - ROOF BEAM 		1	58x170	2856
DB1	DACHBALKE - ROOF BEAM 		2	58x170	2700
	DACHBRETTER - ROOF BOARDS 		55+1	113x18	3505
	FUSSBODENBRETTER - FLOOR BOARDS 		28+1	113x18	2905
	TERRASSENBRETTER (imprägniert) - TERRACE BOARDS (impregnated) 		23+1	120x28	2795
	TERRASSENBRETTER (imprägniert) - TERRACE BOARDS (impregnated) 		3	120x28	2751
	FUSSBODENLEISTE - FLOOR STRIPS 			18x40	12.5 lfm
A44-1	ADAPTER 120x82 Obere seite Upper edge 		✓ ✓	1	120x82 2125
BL-1	DACHBLENDEN - PARAPET 350mm 			2	18x350 2636
BL-2	DACHBLENDEN - PARAPET 350mm 			4	18x350 3600
BS-1	DACHBLENDEN- Blendenstützen - PARAPET- Parapet support 44x65 			8	44x65 200
UPB-1	DACHBLENDEN- U-Profil für Blenden - PARAPET- U-Profile 		✓	4	65x44 20.5 lfm
VL-1	DACHBLENDEN- Verbindungsleisten - PARAPET- connecting strips 350mm 			2	120x18 350
DPL-1	DACHPAPPENLEISTE - ROOFING FELT STRIPS 15x28 		✓		15x28 13.5 lfm
T4-1	TRAUFENLEISTE - EAVES STRIPS 40x18 		✓		40x18 13.0 lfm
Kood	Lucas E 340x320+VD+Terr_Maerjal	File	Leht	2/4	

Pos	Teilleiste/Specification Lucas E 340x320+VD+Terr_44		Stck. Pcs.	Profil Profile (mm)	Länge Length (mm)
SP2-1	STÜTZPFOSTE - SUPPORT POST 90x90	 ✓	1	90x90	2095
SH	SCHLAGHÖLZER - MOUNTING PIECES		3		
HK2	HOLZ-KLOTZEN für verbinden der Wandbohlen - Wooden wedge for connecting the wall parts (122mm)		2		
	DACHPAPPE - ROOFING FELT	 ✓		6.9-6st 41.4m2	
NG3	DACHPAPPNÄGEL - ROOFING NAILS 2.0x18		450		
SR01	SCHRAUBEN - SCREWS 3.0x30	Fussbodenleiste - Floor strips Traufenleiste - Eaves strips 40x18 Dachpappenleiste - Roofing felt Verbindungsleisten - Connecting strips		98	
SR03	SCHRAUBEN - SCREWS 3.5x45	U-Profil für Blenden - Parapet U-Profile Verbindungsstreifen - Connecting strip Türleisten - Window/Door strips		132	
SR11	SCHRAUBEN - SCREWS 5.0x100	Fundamenthölzer - Foundation beams		56	
SR10	SCHRAUBEN - SCREWS 5.0x70	Dachblende - Parapet Blendenstützen - Parapet support		64	
NG1	NÄGEL - NAILS 2.5x50	Dachbretter - Roof boards Fussbodenbretter - Floor boards		886	
NG2	NÄGEL - NAILS 2.5x60	Terrassenbretter - Terrace board		312	
KL-1	Gewindestange - Threaded Rod M12	DACHBALKE - ROOF BEAM		6	170
	Mutter - nut M12 U-Scheibe - washer Ø30	DACHBALKE - ROOF BEAM	 	12	
KL1	Gewindestange - Threaded Rod M8			4	2000
KL2	Gewindestange - Threaded Rod M8			2	460
KL3	Gewindestange - Threaded Rod M8			2	397
KL4	Gewindestange - Threaded Rod M8			2	393
KL5	Gewindestange - Threaded Rod M8			1	338
KL6	Gewindestange - Threaded Rod M8			1	270
	Mutter - nut M8 U-Scheibe - washer Ø25		 	16	
	Befestigungsmutter - fixing nut M8			4	
VS	VERBINDUNGSSTREIFEN für verbinden der Wandbohlen - Connecting strip for connecting the wall parts		3		
VP2	Verstellbare Pfostenstütze - Adjustable post support M16		1		

Pos	Teileliste/Specification Lucas E 340x320+VD+Terr_44			Stck. Pcs.	Profil Profile (mm)	Länge Length (mm)
ML1	Metallstange - Metal bar			1	D10	970
ML2	Metallstange - Metal bar			1	D10	900
ML3	Metallstange - Metal bar			1	D10	770
ML4	Metallstange - Metal bar			3	D10	490
ML5	Metallstange - Metal bar			3	D10	360
	<b>TÜR/DOOR 2760x1955</b>  LU3-GH+ Die Leisten für eine Tür/ Strips for 1 door L1 18x90 L=3000mm 2 Stck/Pcs. L2 18x90 L=1955mm 4 Stck/Pcs. ✓			1	LU3-GH+	
	<b>FENSTER/WINDOW 650x1430</b>  A42-29KV iso Die Leisten für eine Fenster/ Strips for 1 Window L1 18x90 L=890mm 2 Stck/Pcs. L2 18x90 L=1550mm 4 Stck/Pcs. L3 18x90 L=650mm 2 Stck/Pcs. ✓			2	A42-29KV iso Ohne Sprossen without muntins	
	✓ - Bitte selber anpassen (falls nötig)! / Cut into length on site (if needed)!					