

Problems	Reasons	Maintenances
No power or electricity leaking protection device is activated	<ol style="list-style-type: none"> 1.Electricity leaking protection device cut off power source when electricity line is not well connected. 2.Power or electricity circuit have phenomenon of electricity leaking. 	<ol style="list-style-type: none"> 1.check and reconnect the wiring system. 2.check the power source, electricity circuit and ground line.
Water Jets are not working.	<ol style="list-style-type: none"> 1.check the system whether is on. 2.the impeller of water pump doesn't rotate 3.water pump is broken which caused by working without water coming in. 	<ol style="list-style-type: none"> 1. turn on the system 2. check through and remove the garbage which is inside the pump. Switch pipe can be removed. 3. install a new water pump
The intensity of hydro-massage cannot be adjusted	<ol style="list-style-type: none"> 1. water pump's suction has not enough power. 2.air adjustment valve is abnormal 3.jets or nozzles are blocked 	<ol style="list-style-type: none"> 1. check the water pump whether is working normally. 2.change the air adjustment valve 3. remove things which are blocking the jets.
Water leaks from the pipes.	<ol style="list-style-type: none"> 1.seal ring is broken 2.screws doesn't lock tightly 3.pipes doesn't seal properly. 4.water pipe is broken 	<ol style="list-style-type: none"> 1.chang seal ring 2. lock the screws tightly 3. re-seal the silicone. 4. change water pipe
Control panel doesn't work	<ol style="list-style-type: none"> 1.Electricity line didn't connect to power source, electricity leaking protection device cut off power. 2.power button is not working. 	<ol style="list-style-type: none"> 1.Re-connect the power source and check the electricity leaking switch button. 2.change a new control panel <p>Lighting is off</p>
No lighting	<ol style="list-style-type: none"> 1.The bulb is broken 2. power line is disconnected. 3.control panel is broken 	<ol style="list-style-type: none"> 1.change a new bulb. 2.re-connect the circuit. 3 .maintain or change control panel
Radio is off	<ol style="list-style-type: none"> 1.speaker is broken 2. power line is disconnected. 3.control panel is broken 	<ol style="list-style-type: none"> 1.change a new speaker 2.reconnect the circuit. 3. maintain or change control panel

WS-S38

PRODUCT MANUAL

★All we do our best for the particular and definitude of the products information making , but only for reference , please depend on the practise and reality in detail .

★Our company keep down the authority of amending the aspects and the spare parts , according as the scheme's or parameter's redressal which was come out from technical renewal , sorry to will not offer any notice.

★our company reserve the final explanation and modify right for all the contents.

Dear user,

Thank you very much for purchasing our sanitary ware. To enable you to use this product safely and effectively, please read this installation and operation manual carefully before use.

Cautions

1. Please connect the water pipe before installed the products. (Fig.1)
2. Please ensure that the product installed reliable electric leakage protection device, the power plug contains earth line, and make sure it is reliable earthing. Check the protect system of leakage protection each time before use.
3. Before turn on water pump, check if the water level over jets 10 to 20 mm or not, make sure regular usage of water pump otherwise it will be destroy because of water leakage.
4. Do not turn on water pump, heat pump or air bubble pump without water.
5. People with Hypertension symptom, after drink or heart disease are not allowed to use this product . Children have a bath must under adult's guidance.
6. During use please noticed that don't blocked the jets . Also keep this product clean and don't let it blocked by hair or mess.
7. During use, please firstly adjust the water temperature or it will be burned.
8. The outdoor spa is designed with ergonomic, rise and fall changes are dis tiuctly, so pay more attention of slip.
9. Please shut down the system when not use.

Technical Parameter

Size: 3800x2120x1110mm

Voltage: 220-240V 50Hz/60HZ

Hydraulic pressure : 0.1~0.2Mpa

Power of water pump : 2200W×3

Filter pump : 750W

Air pump : 700W

Power of heat pump A and B : 3000W×2

Color changing light: 12V, 100mA

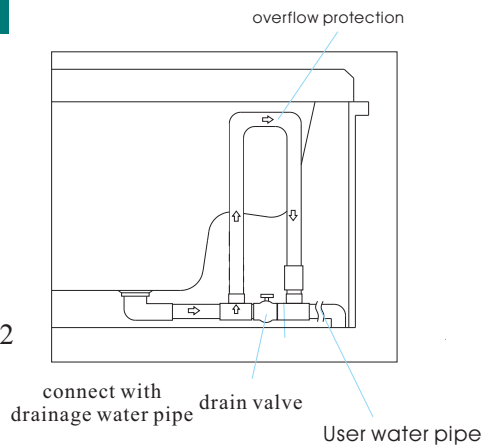

6. After turn on all the pump, turn air adjustor 1, 2 and 3 widdershins, it make the jets about more prowful
7. After turn on the pump1, turn water column switch widdershins, you can open the water column

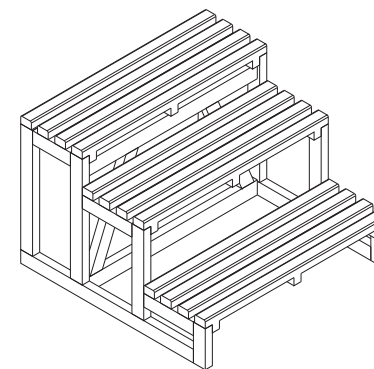
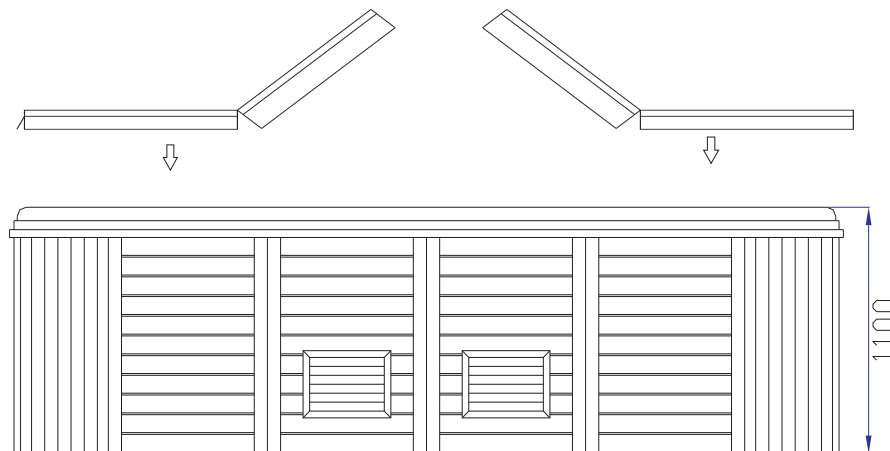





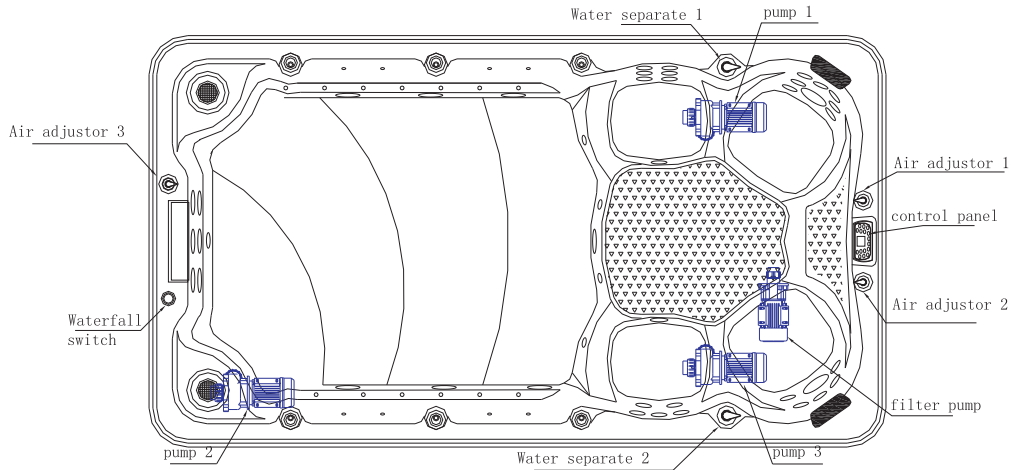
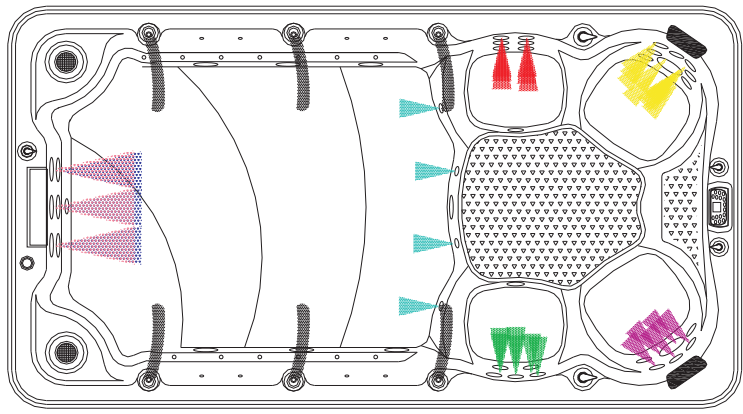







Stairs and spa covers are the extra options for the spa.

Cleaning and Maintenance



Turn on the control system

- 1、 Press , water will spray from **water column** and 
- 2、 When turn water separate device 1 widdershins, water will spray from , turn deasil, water will spray from 
- 3、 When turn water separate device 2 widdershins, water will spray from , turn deasil, water will spray from 
- 4、 Press , water will spray from 
- 5、 Press  CYCLE, water will spray from 
- 6、 Press  PREHEAT, water will spray from 

1. The daily maintenance of outdoor spa should be cleaned with ordinary detergent and soft cloth. Please do not use the detergent which contains acetone or ammonia liquid. If there marks or something like glue on the surface of bathtub, just polish it with soft cloth dipping with gas.
2. If there are scratches on bathtub surface, please polish it with 1500# frosted paper dipping with liquid and burnish it with toothpaste. It will be shining again after that.
3. If there are furring on the surface of bathtub, it can be take away by mild acid detergent, for example wipe the bathtub with lemon juice or vinegar which be heated.
4. Do not wipe the chrome plated spare parts all the time, and do not get in touch with chemical detergent etc. Otherwise the surface of chrome plated will be destroyed. The product should be clean by soft cloth other than coarse cloth.
5. To check the water pipe regularly in order to avoid troubles from crack of water pipes or blocked inside.
6. If there are something such as hair stuck inside the jets, then just to twist out the jets and remove it.
7. To clean hydro-massage equipment: To full fill hot water which is 40'C, and pour 2g/L detergent, start hydro-massage function more than 5 minutes, then turn off the massage function and drain out the water. Next, to full fill cold water and start hydro-massage function for 3 minutes, then turn off the massage function and drain out the water, at last, to dry the bathtub with towel.
8. Filter should be clean once a week.
9. Keep out from combustibles and goods which over 80°C to avoid fire disaster and damage the product.
10. The bathtub should be transported carefully. Do not lay heavy things on it and do not bump and shaking the tub. If the bathtub has not been used for a long time, drain out the water of the bathtub and keep it in a dry and ventilate environment. Avoid corrosive gas.

INSTALL SKETCH

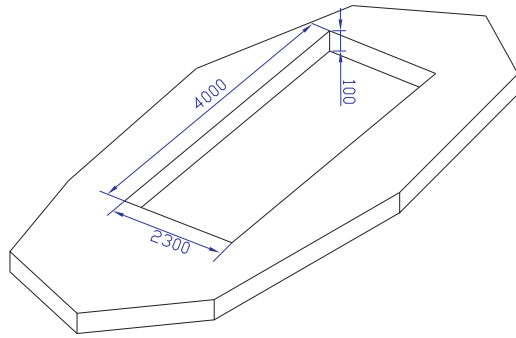

The location where to place the swimming spa should be in sunken dug pit measure: 620mm0×26 mm0×mm100

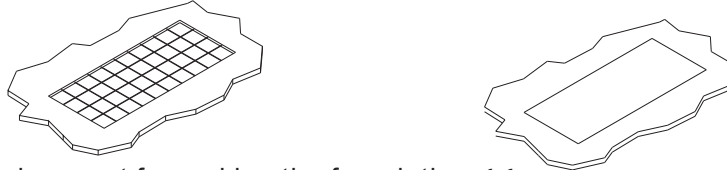

Use steel and cement for making the foundation slab

Note: Very important the foundation strength supports the spa

Filter Cleaning

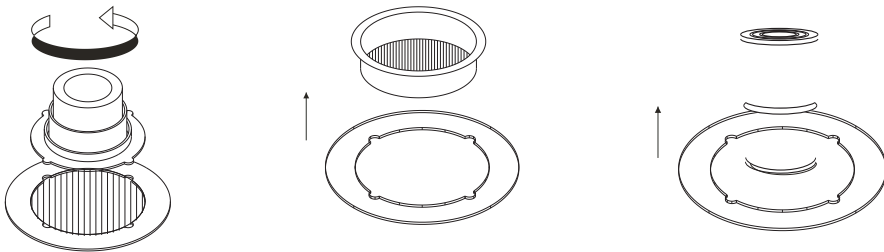

1 move out the cover

2 pull out the skimmer basket

3 Take out the filter core then clean with water or detergent.

Construction Sketch

