

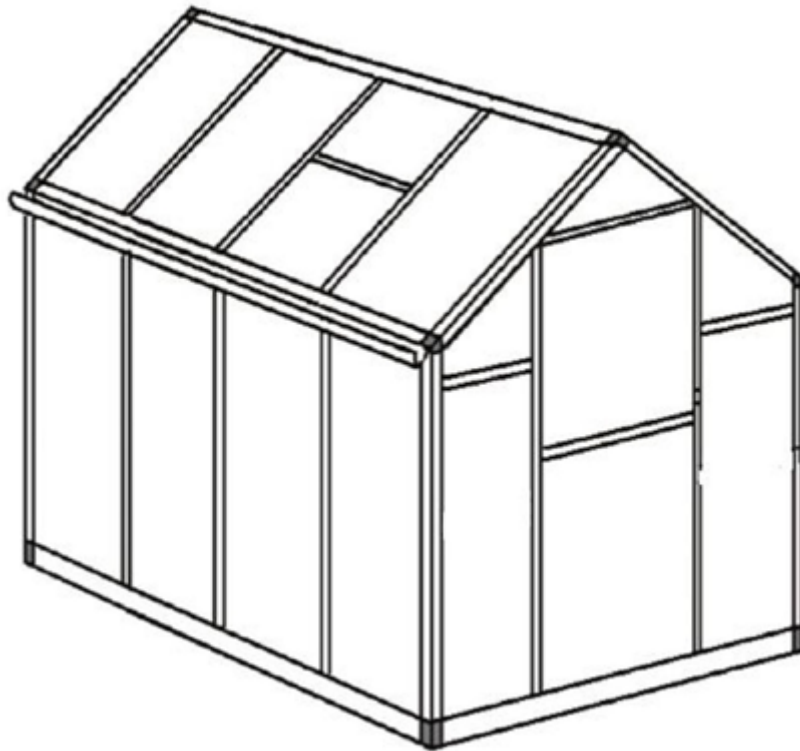









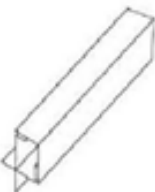
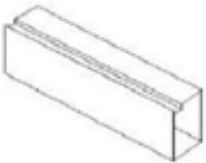

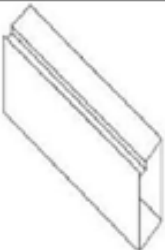
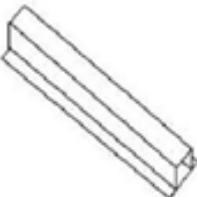
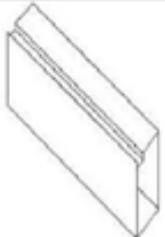
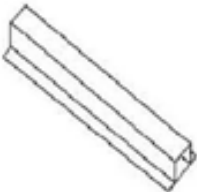
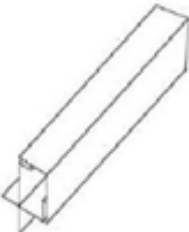
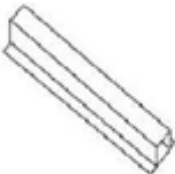

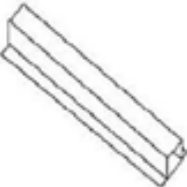

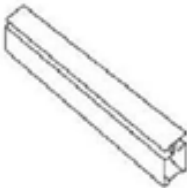
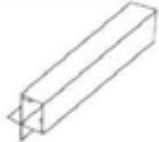
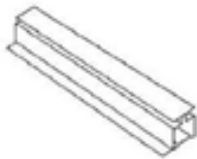
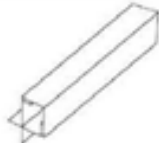
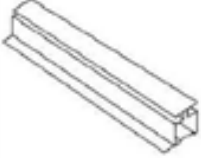
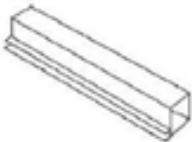
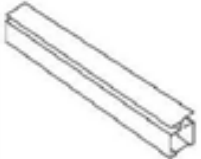
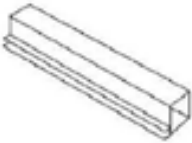

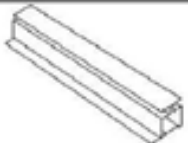





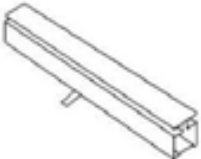
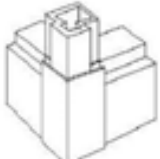



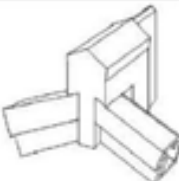















Monteringsanvisning  
Växthus Venus - 4,6 m<sup>2</sup>  
49408



Nr.	Illustration	Antal	Storlek	Nr.	Illustration	Antal	Storlek
1		2	117.9	10		1	98.2
2		2	117.9	11		1	98.2
3		1	172	12		1	164.3
4		1	172	13		1	164.3
5		4	130.3	14		1	165.8
6		2	117.9	15		1	165.8
7		2	117.9	16		6	130.3

8		1	98.2	17		4	96.9
9		1	98.2				
18		2	96.9	26		1	155
19		2	51.7	27		1	56.3
20		2	54.6	28		1	56.3
21		1	63	29		1	56.3
22		1	57	30		1	57*57
23		2	117.9	31		4	117.9
24		1	57	32		4	
25		1	155	33-1		2	
				33-2		2	
34		2		A		8	3.8*133.5*58.8

35		24		B		7	3.8*99*58.8
36		4		C		2	3.8*129.1*56
37		2		D		1	3.8*129.1*58.3
38		8		E		2	3.8*35.5*56
39		56		F		1	3.8*53.5*58.3
40		1		G		2	3.8*129.1*53.1
41		8					
42		4					
H			2				3.8*33.9*53.3
I			1				3.8*19.3*63
J			1				3.8*37*58.3
K			2				3.8*77.6*57.6
44			4	46			4
45			4	47			

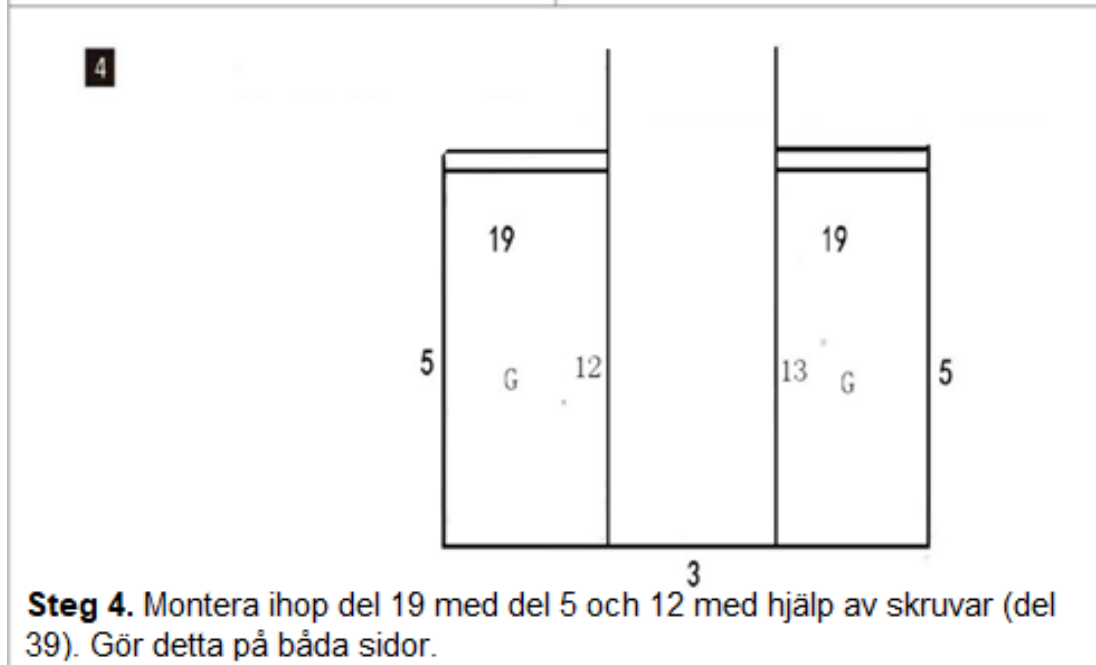
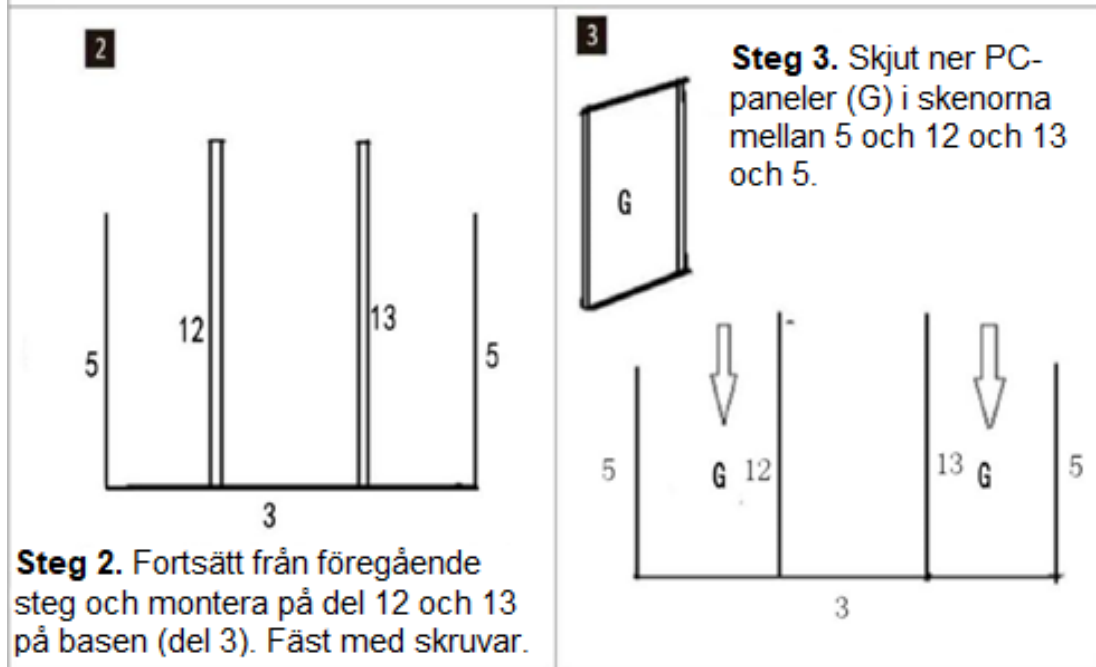
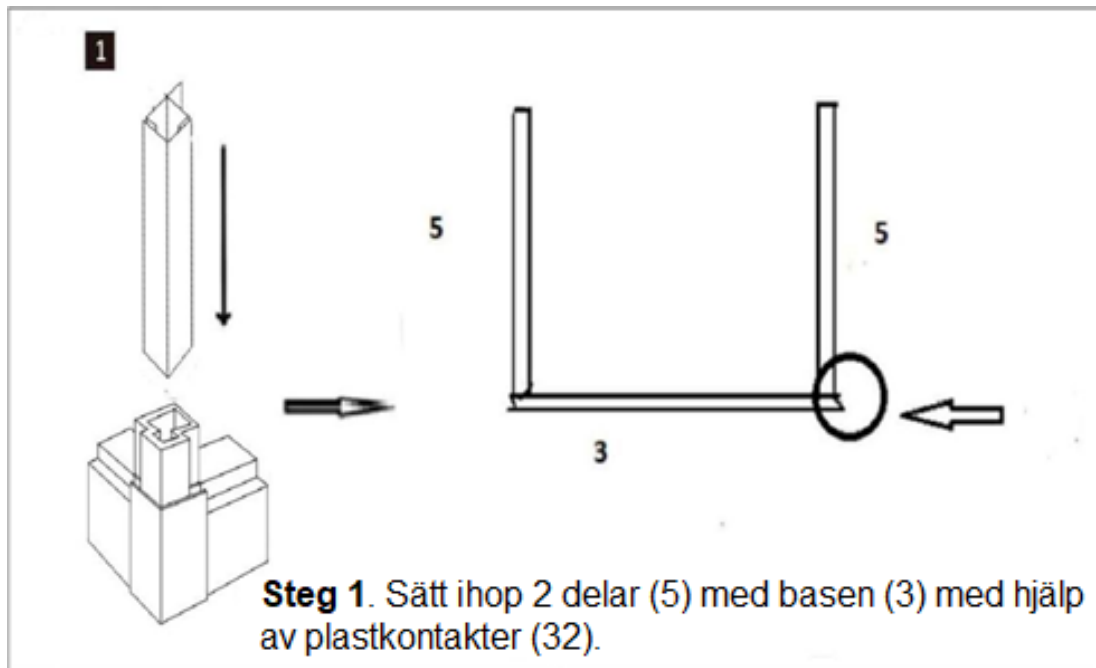

**5**

**Steg 5.** Glid ner paneler (H) i skenorna mellan 5 och 12 samt mellan 13 och 5. Fäst sedan med skruvar.

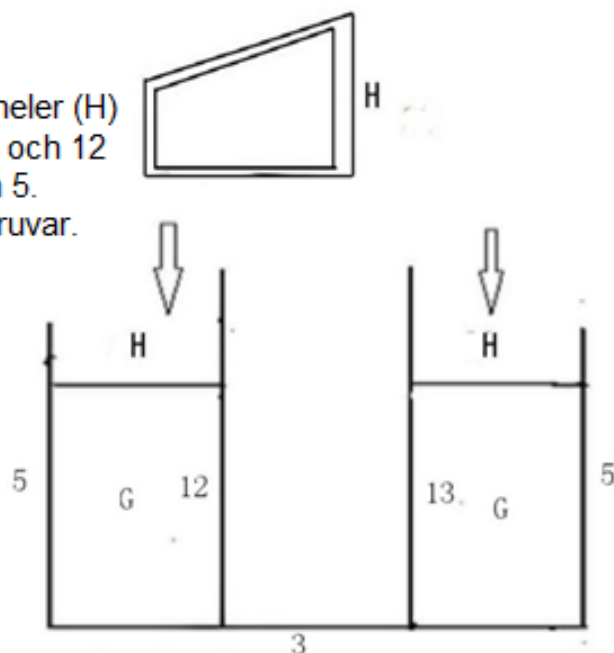
**6**

**Steg 6.** Montera ihop del 8 och 9 med hjälp av del 34. Sätt sedan ihop del 8 och 9 med del 5 med hjälp av 33-1 och 33-2.

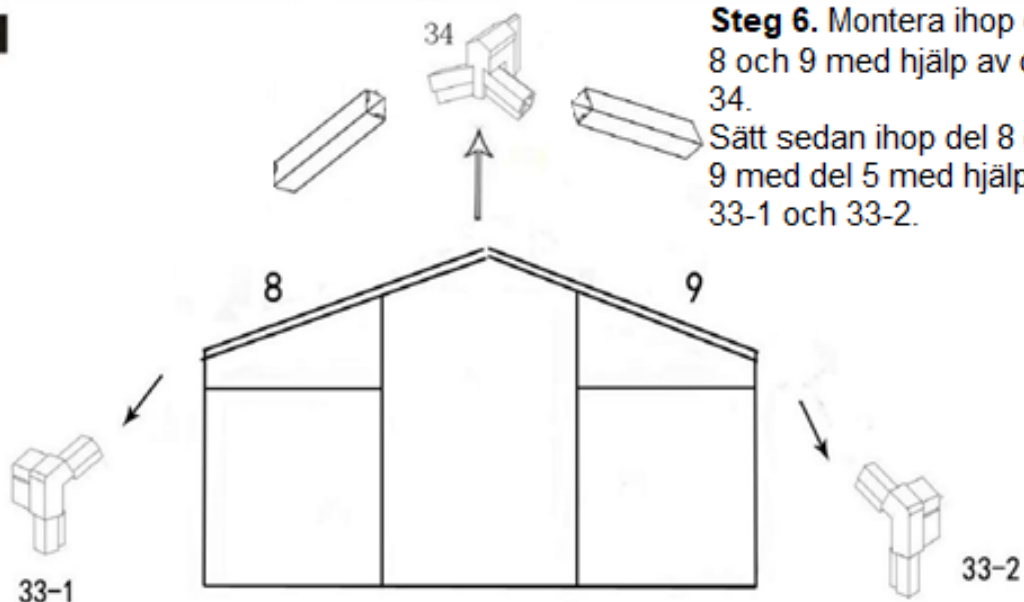
**7**

**Steg 7.** Glid in panelen (I) i skenorna på del 8 och 9. Montera sedan på del 21 mellan del 12 och 13.

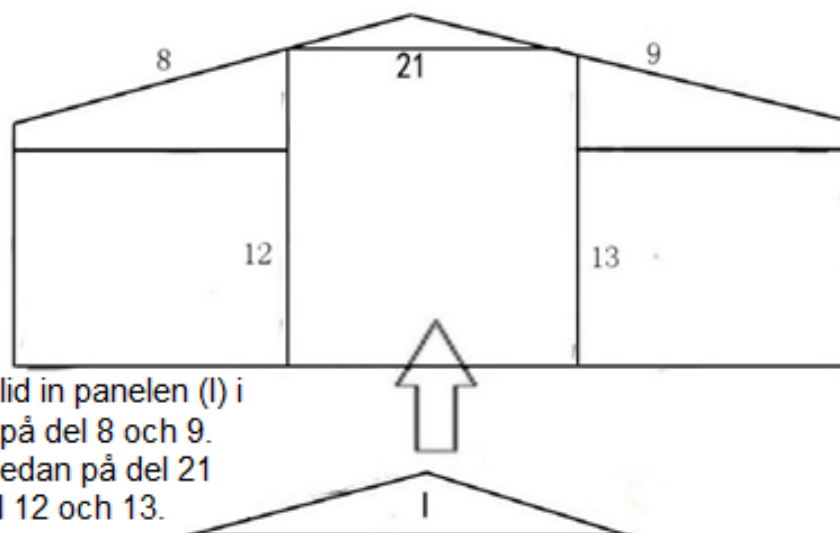

Fäst sedan allt med skruvar.

8

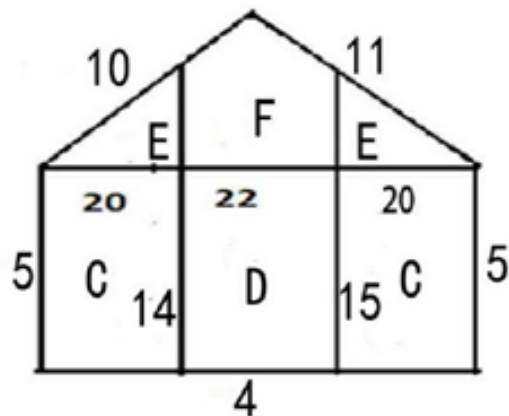

**Steg 8.** Gör nu samma sak för andra gaveln, enligt ovan illustration.

9

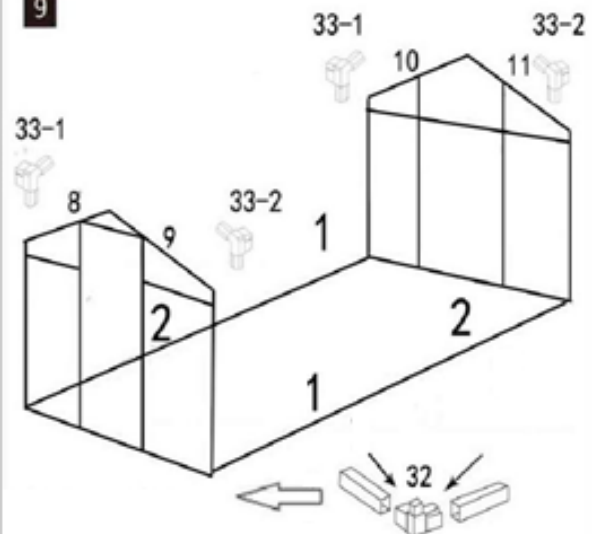

**Steg 9.** Fäst nu ihop gavlarna med hjälp av del 1, 2 och 32. På båda sidor.

10

### Steg 10.

Montera nu ihop del 6 och 7 med del 5 i båda gavlarna och på bägge sidorna.

Använd 33-1 och 33-2 enligt föregående illustration.

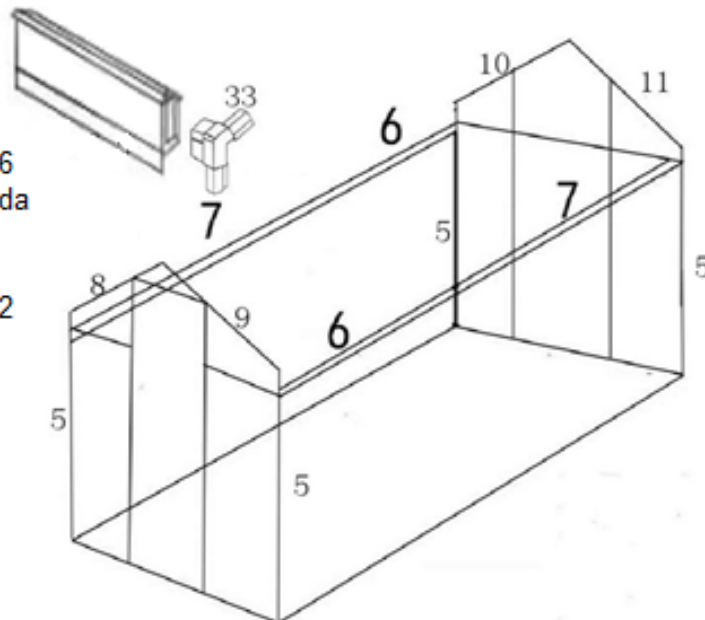

11

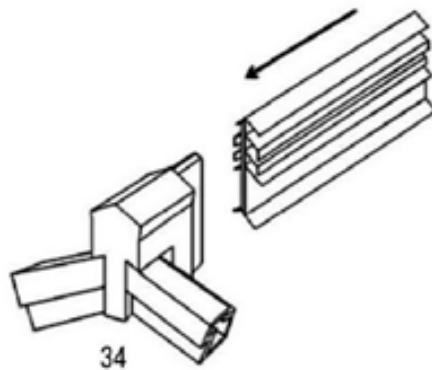

### Steg 11.

Montera ihop 2 st del 23 och fäst dem i gavlarna med del 34.

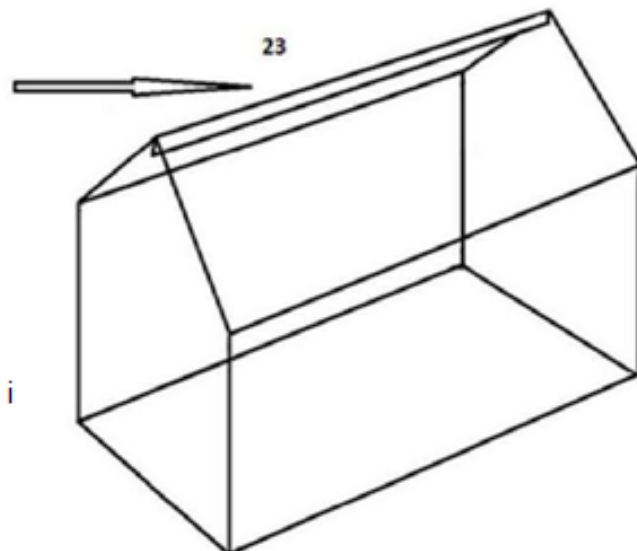

12

**Steg 12.**

Montera nu takstolarna 17 och 18 med skruvar.

**Obs!** Spänn inte skruvarna än!

Del 18 är de takstolarna där fönstret ska sitta imellan.

Fäst sedan del 24 mellan dessa 2 takstolar (del 18).

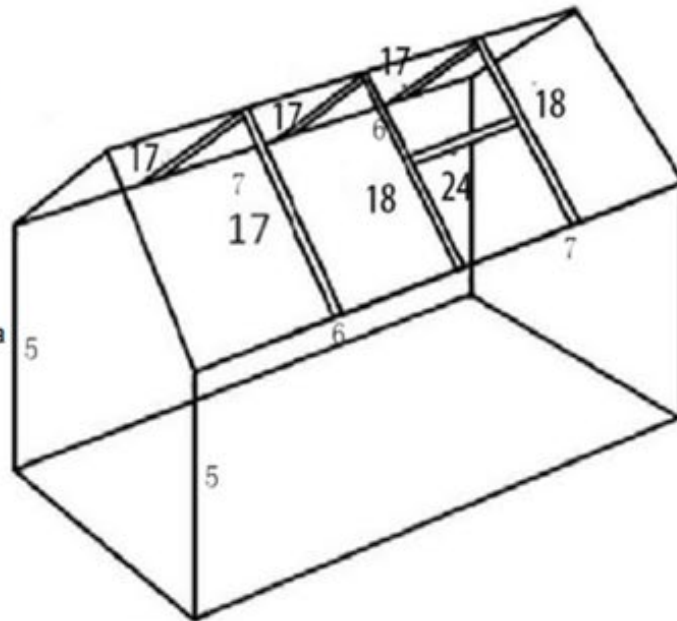

13

**Steg 13.**

Montera sidostolparna (16) på bägge sidor med skruvar (35).

**Obs!** Spänn inte åt skruvarna helt än.

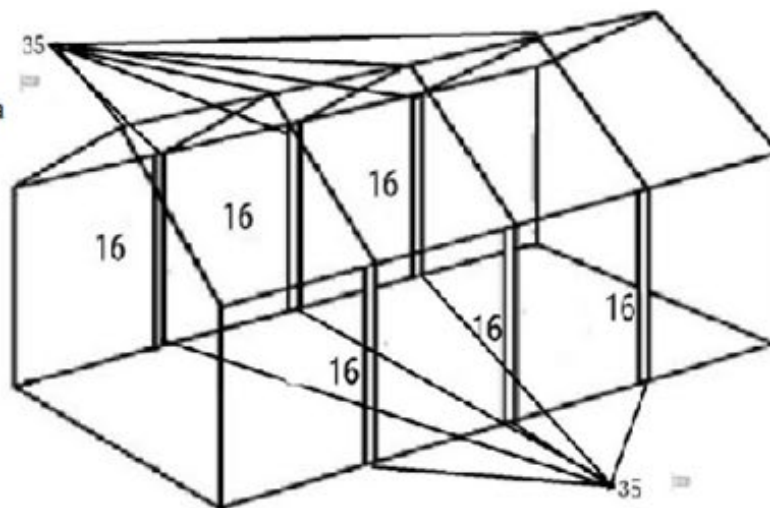

14

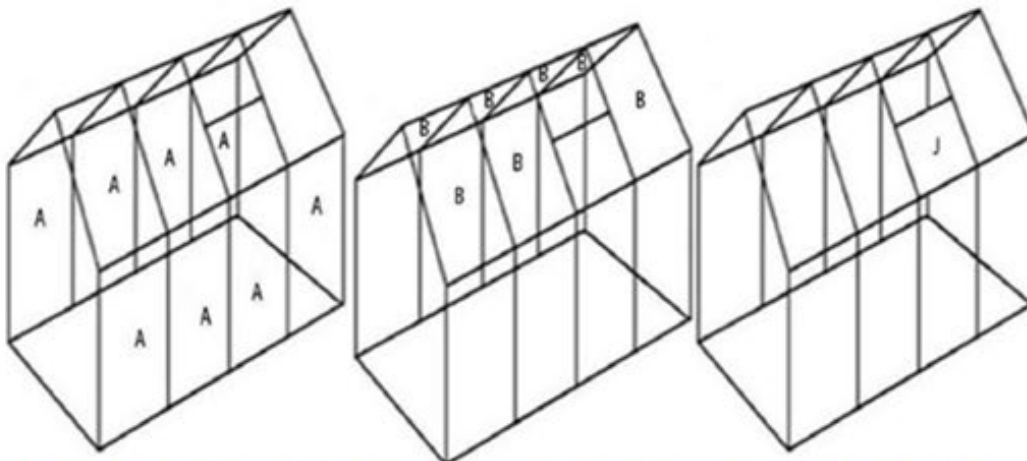

**Del 14.** Glid in panelerna (A) på långsidorna. Därefter takpanelerna (B) och till slut panel (J). Panel J ska sitta under fönstret.



- 15 Steg 15.** Om du vill ansluta en vattenslang till avrinningsprofilen, gör det nu. Montera sedan avrinningsprofilen (31) till takfoten med skruvar.

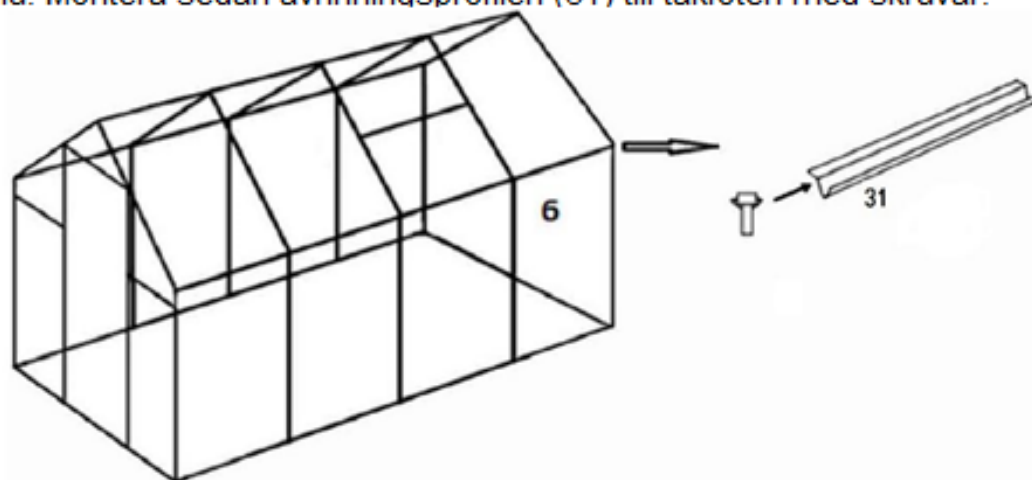

**16**

**Steg 16.**

Montera nu takfönstret, glid det på skenan på taknocken med riktning från gaveln och innåt.

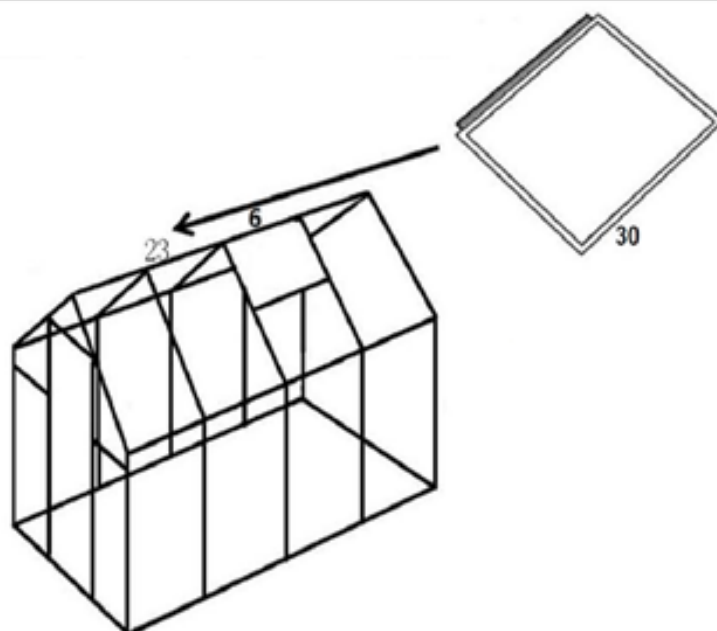

- 17 Steg 17.** Dörrmontering. Montera ihop 25 och 27 med en hörnformad plastanslutning. Glid sedan in en panel K i skenorna på 27 och 28. Glid sedan in den andra panelen K i skenorna på 28 och 29. Slutligen, anslut 26 till dörren med hjälp av hörnformade plastanslutningar.

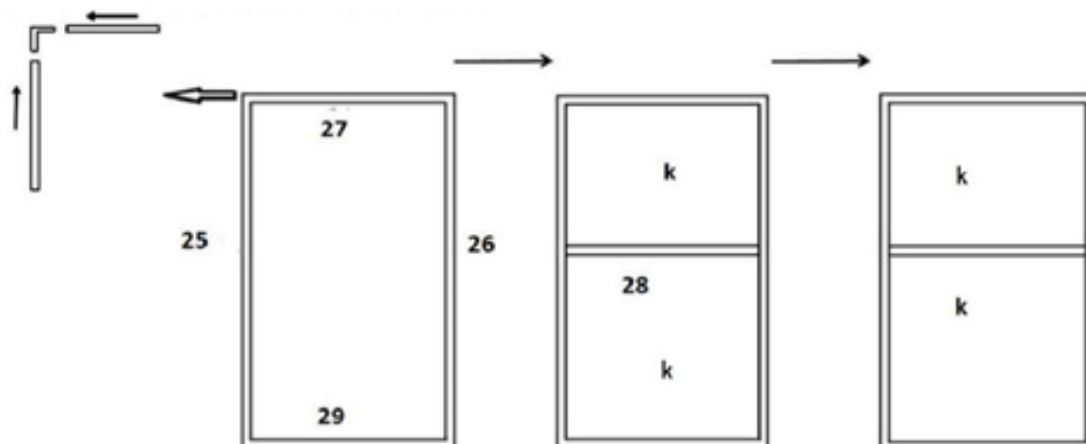

Om ni vill montera på  
fundamentet på basen, montera  
44 på insidan av växthusbasen.  
Fäst den med 45 och 46.

