

# Monteringsanvisning

## Bas till växthus

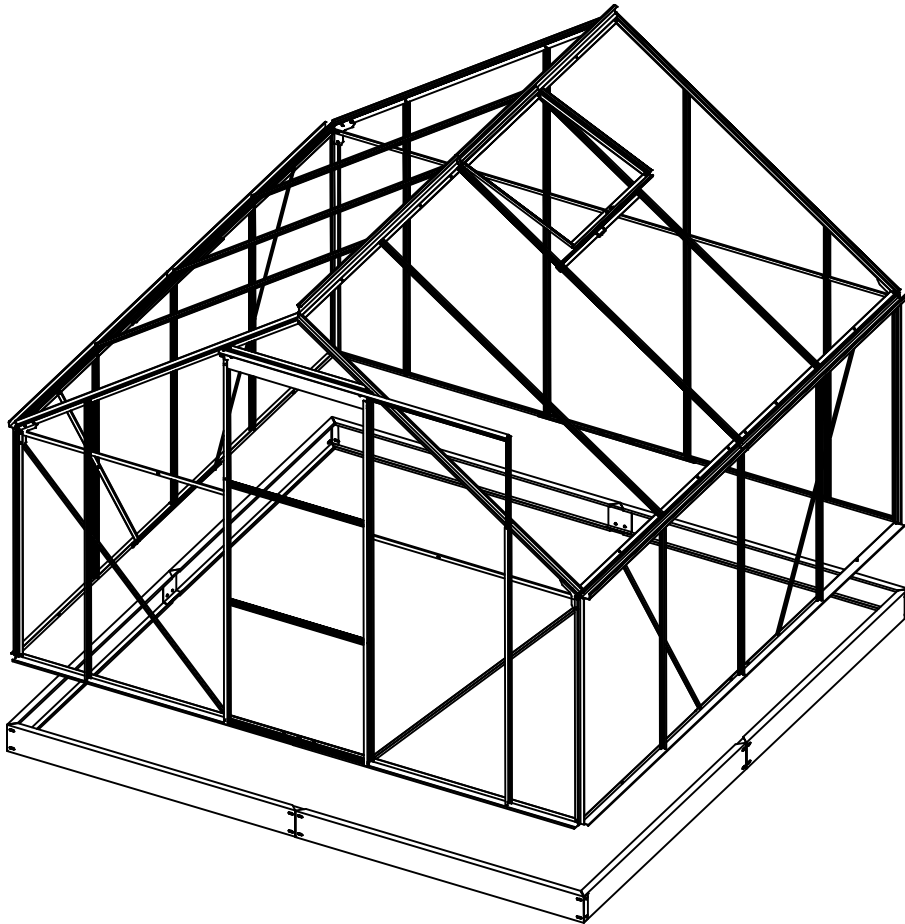

2500mm(L)x2500mm(W)x1950mm(H)

### **VIKTIGT!**





Ni måste läsa igenom dessa instruktioner noggrant innan ni påbörjar monteringen.

Obs! Säkerställ innan montering så att inga delar saknas.

Kontrollera både märkningen och antalet med hjälp av listan som finns i denna manual.

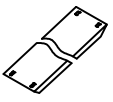
Spänn inte åt skruvarna innan det att ramen är färdigmonterad och polykarbonatpanelerna har monterats.

Spara dessa instruktioner för framtida referens.

Bild	Nr.	Antal
	2	8
	3	4
	29	4
	F3	32





Bild	Nr.	Antal
	B2	22





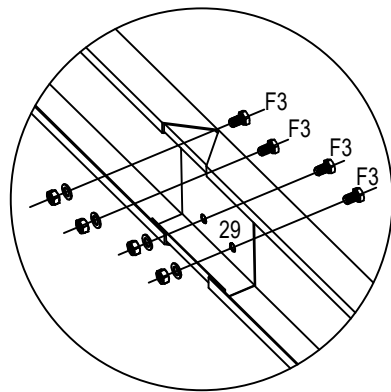
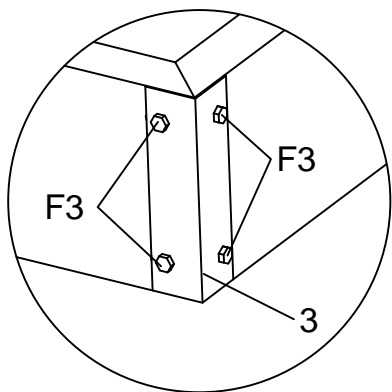
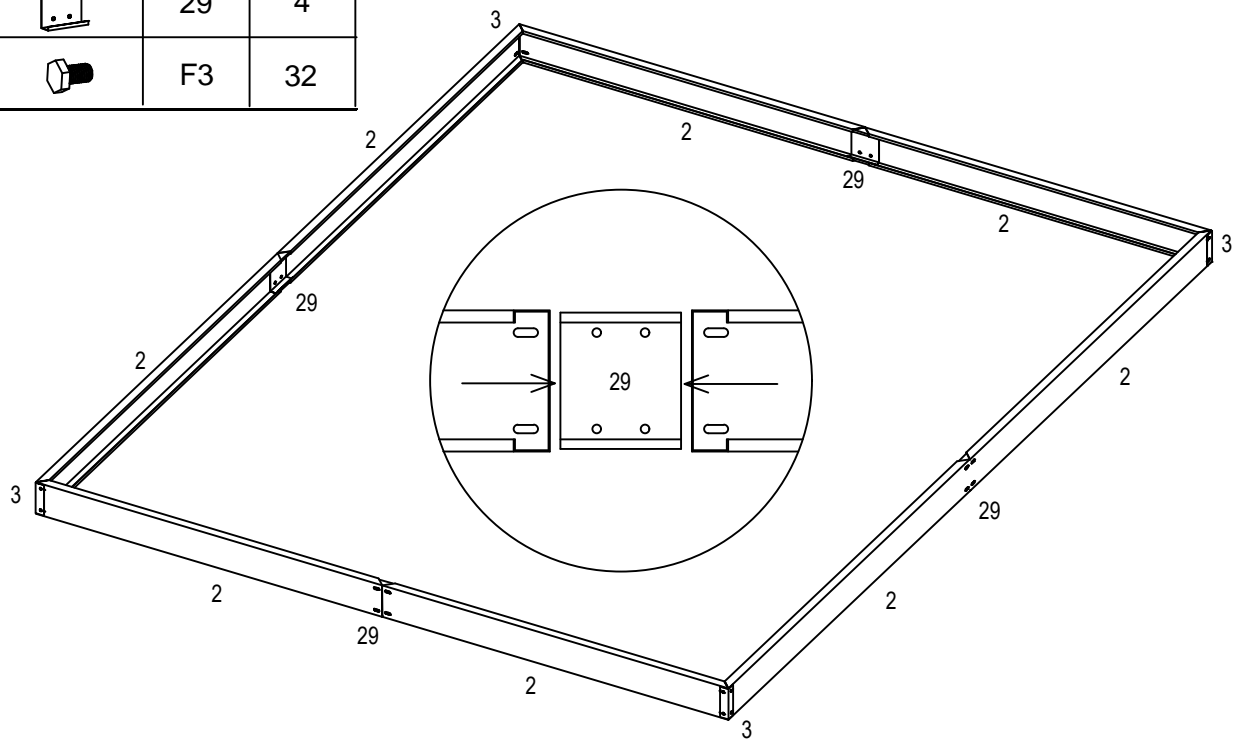

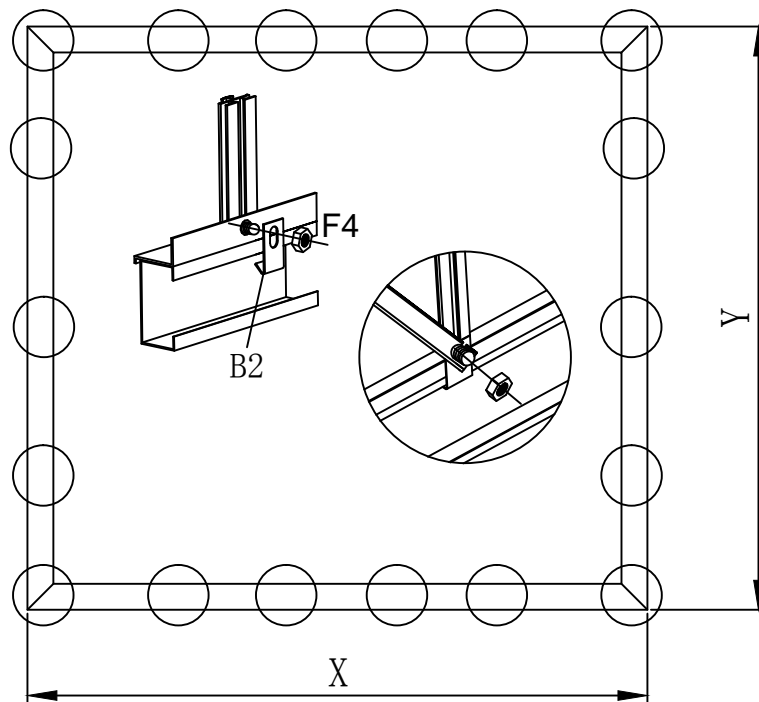
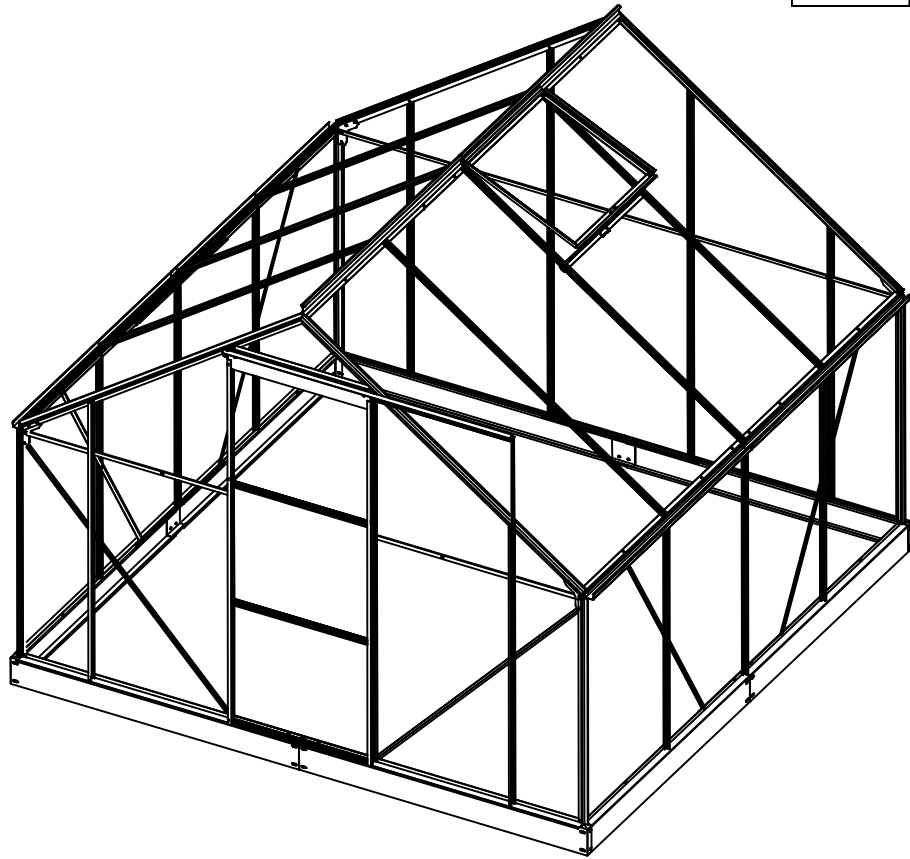
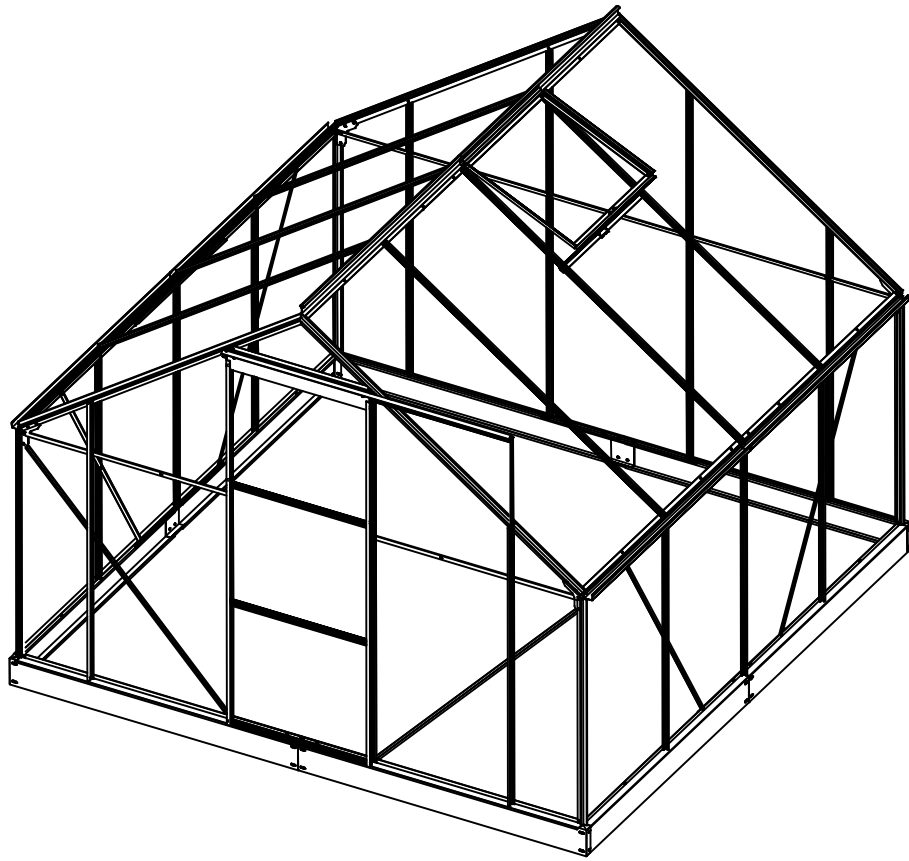
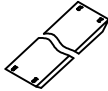

Bild	Nr.	Antal
	2	8
	3	4
	29	4
	F3	32
	B2	22